

# AVX GiGUARD ESD PROTECTION DIODES

CUTTING EDGE MINIATURE LEADLESS TVS DIODES  
FOR ESD PROTECTION OF HIGH SPEED SIGNAL LINES

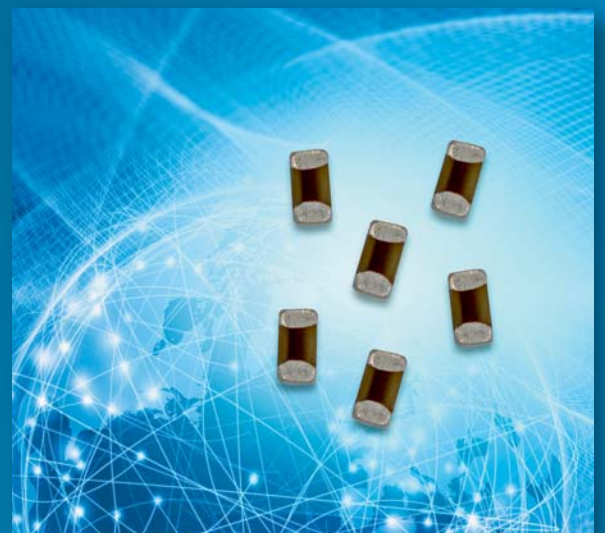

# GiGuard - ESD Protection for High Speed Circuits

## AVX Bi-directional Leadless Transient Voltage Suppressor Diodes Provide ESD Protection for High Speed Communication and Data Lines



### GENERAL DESCRIPTION

Utilizing the latest in TVS Technology combined with a unique leadless package, the new GiGuard series of ESD Suppression Diodes offers Clamping Voltages below 12v and cap values as low as 0.3pfd. This combination of excellence both protects sensitive ICs during ESD events and preserves the integrity of the protected high speed signals. The AVX GG series fits perfectly onto the same PCB solder pads as standard EIA 0201/0402 components.

The GG series complies with IEC 61000-4-2(ESD), Level 4+ ( $\pm 20kV$  air,  $\pm 20kV$  contact discharge), IEC 61000-4-4 (electrical fast transient -EFT) (20A, 5/50 ns), very fast charged device model (CDM) ESD and cable discharge event (CDE).



### APPLICATIONS

- USB 2.0/3.0
- Tablets/Cell Phones Touch Screens
- Network Communications
- Gigabyte Ethernet
- High Def Multimedia Interface (HDMI)
- Mobile Phone Touchscreen

### FEATURES

- Low Capacitance (.3pF to 17pF typ)
- Low Vc (<12v @ 1a)
- Bi-Directional protection
- Leadless 0201/0402 case size
- 125°C Operating Temp/ 150°C Storage

### CIRCUIT DIAGRAM

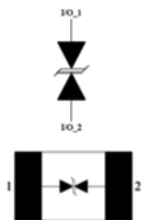

### HOW TO ORDER

|               |                  |                       |   |  |   |               |
|---------------|------------------|-----------------------|---|--|---|---------------|
| <b>GG</b>     | <b>0201</b>      | <b>05</b>             | <b>100</b>  | <b>N</b>   | <b>2</b>  | <b>P</b>      |
| <b>Series</b> | <b>Case Size</b> | <b>Voltage Rating</b> | <b>Nominal Cap</b>  | <b>Cap Tolerance</b>                               | <b>Packaging</b>                                  | <b>Finish</b> |
|               | 0201<br>0402     | 05 = 5V               | 0R3 = 0.3pF<br>2R5 = 2.5pF<br>5R0 = 5.0pF<br>100 = 10pF<br>170 = 17pF | 4 = $\pm 2pF$<br>C = $\pm .25pF$<br>N = $\pm 30\%$ | 2 = 7" Reel<br>0201 = 15K/Reel<br>0402 = 10K/Reel | P = 100% Tin  |

### ELECTRICAL CHARACTERISTICS

| AVX Part Number | V <sub>rrm</sub> (V) | C <sub>nom</sub> (pF) | Cap (pF) |     | V <sub>br</sub> Min (V) | IL ( $\mu$ a) | P <sub>pp</sub> (W) | I <sub>pp</sub> (A) | V <sub>air</sub> (KV) | V <sub>con</sub> (KV) | V <sub>d8k</sub> (@8KV) (V) | V <sub>d</sub> (@I <sub>pp</sub> =1a) (V) | V <sub>dip</sub> (@I <sub>pp</sub> ) (V) |
|-----------------|----------------------|-----------------------|----------|-----|-------------------------|---------------|---------------------|---------------------|-----------------------|-----------------------|-----------------------------|---|--|
|                 |                      |                       | Min      | Max |                         |               |                     |                     |                       |                       |                             |   |  |
| GG020105100N2P  | 5                    | 10                    | 7        | 13  | 5.5                     | <0.1          | 60                  | 6                   | $\pm 20$              | $\pm 20$              | $\leq 12$                   | $\leq 8$                                  | $\leq 12$                                |
| GG0402050R3C2P  | 5                    | 0.3                   | 0.05     | 0.6 | 7.0                     | <0.1          | 46                  | 3                   | $\pm 20$              | $\pm 20$              | $\leq 30$                   | $\leq 12$                                 | $\leq 15.5$                              |
| GG0402052R542P  | 5                    | 2.5                   | 0.5      | 4.5 | 5.5                     | <0.1          | 46                  | 3                   | $\pm 15$              | $\pm 15$              | $\leq 16$                   | $\leq 12$                                 | $\leq 15.5$                              |
| GG0402055R042P  | 5                    | 5                     | 3        | 7   | 5.2                     | <0.1          | 60                  | 4                   | $\pm 15$              | $\pm 15$              | $\leq 15$                   | $\leq 12$                                 | $\leq 16$                                |
| GG040205100N2P  | 5                    | 10                    | 7        | 13  | 5.5                     | <0.1          | 96                  | 8                   | $\pm 25$              | $\pm 25$              | $\leq 12$                   | $\leq 8$                                  | $\leq 12$                                |
| GG040205170N2P  | 5                    | 17                    | 11.9     | 22  | 5.1                     | <0.1          | 80                  | 8                   | $\pm 30$              | $\pm 30$              | $\leq 12$                   | $\leq 6.5$                                | $\leq 10$                                |

| Characteristic Test Description            | Symbol           | Units |
|--|------------------|-------|
| Nominal Reverse Working Voltage            | V <sub>rrm</sub> | V     |
| Reverse Min. Breakdown Voltage @ 1ma       | V <sub>br</sub>  | V     |
| Reverse Leakage Current @V <sub>rrm</sub>  | IL               | ua    |
| Peak Pulse Power (tp=8x20us)               | P <sub>pp</sub>  | W     |
| Peak Pulse Current (tp=8x20us)             | I <sub>pp</sub>  | A     |
| ESD Rating - Air (150pf, 330Ω network)     | V <sub>air</sub> | KV    |
| ESD Rating - Contact (150pf, 330Ω network) | V <sub>con</sub> | KV    |

| Characteristic Test Description           | Symbol           | Units   |
|---|------------------|---------|
| Max Clamp Voltage @ I <sub>pp</sub> = 16a | V <sub>d16</sub> | V       |
| Max ESD Clamp Voltage @ 8KV               | V <sub>d8k</sub> | V       |
| Max Clamp Voltage @ I <sub>pp</sub> = 1a  | V <sub>d</sub>   | V       |
| Max Clamp Voltage @ I <sub>pp</sub>       | V <sub>dip</sub> | V       |
| Nominal Capacitance (Vr=0v, f=1Mhz)       | C <sub>nom</sub> | pF      |
| Allowable Capacitance Range               | Cap (pF)         | min-max |

## Characteristic Curves - Typical

### GG020105100N2P (10PF)

TLP Measurement

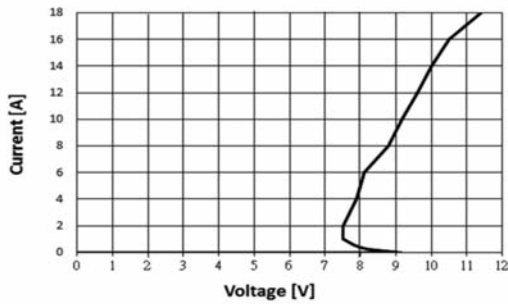

Voltage Sweeping of I/O\_1 to I/O\_2

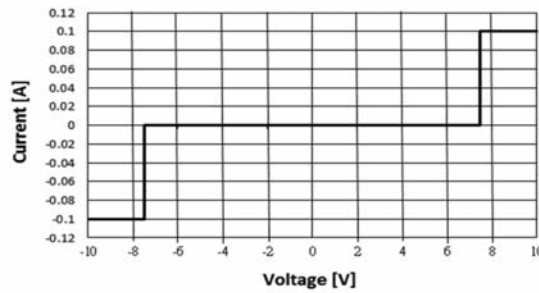

ESD Clamping of I/O\_1 to I/O\_2  
(+8kV Contact per IEC 61000-4-2)

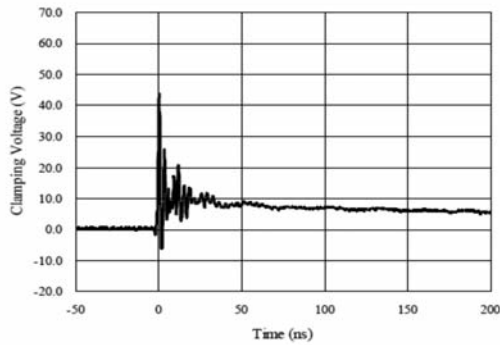

ESD Clamping of I/O\_1 to I/O\_2  
(-8kV Contact per IEC 61000-4-2)

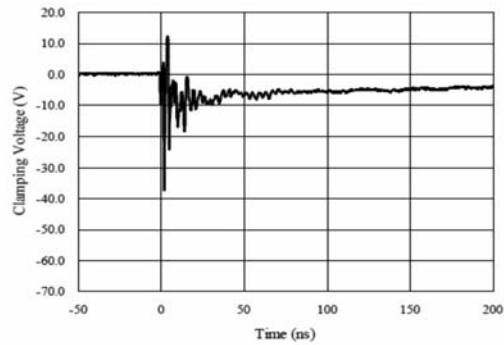

### GG0402050R3C2P (0.3PF)

TLP Measurement

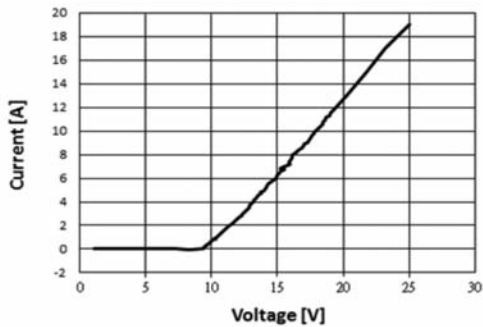

Voltage Sweeping of I/O\_1 to I/O\_2

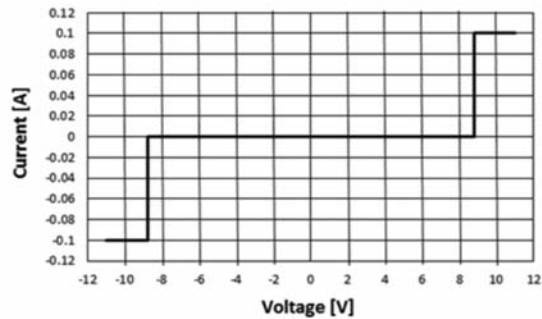

ESD Clamping of I/O\_1 to I/O\_2  
(+8kV Contact per IEC 61000-4-2)

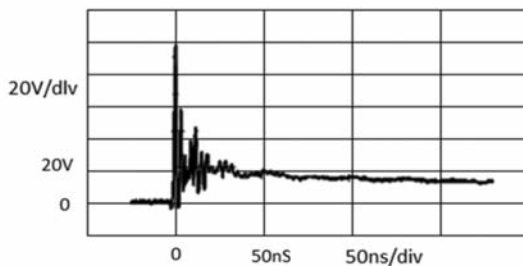

ESD Clamping of I/O\_1 to I/O\_2  
(-8kV Contact per IEC 61000-4-2)

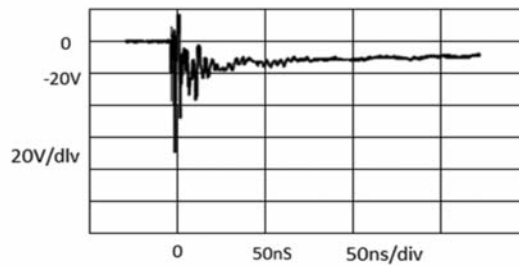



## Characteristic Curves - Typical

### GG0402052R542P (2.5PF)

TLP Measurement

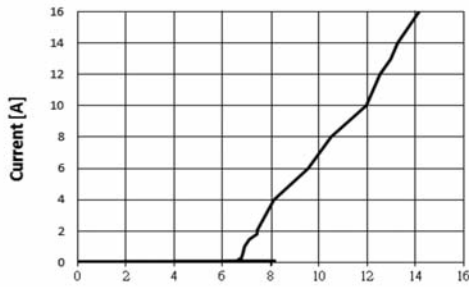

Voltage Sweeping of I/O\_1 to I/O\_2

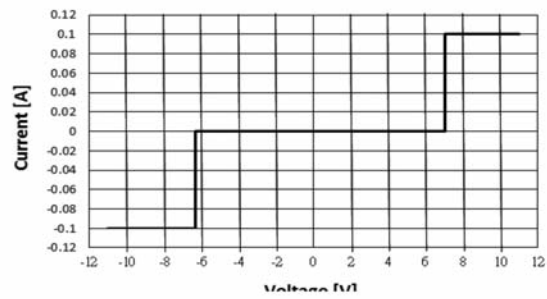

ESD Clamping of I/O\_1 to I/O\_2  
(+8kV Contact per IEC 61000-4-2)

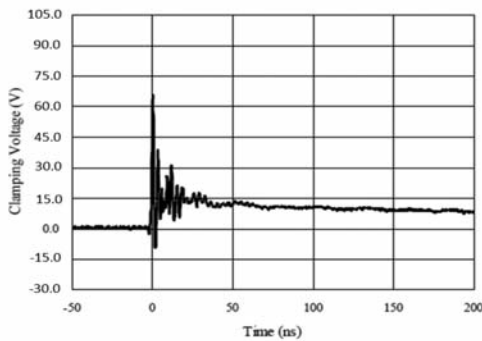

ESD Clamping of I/O\_1 to I/O\_2  
(-8kV Contact per IEC 61000-4-2)

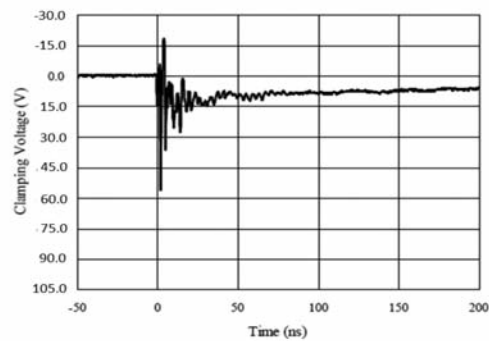

### GG0402055R042P (5.0PF)

TLP Measurement of I/O\_1 to I/O\_2

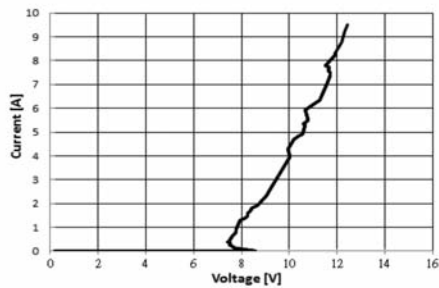

Voltage Sweeping of I/O\_1 to I/O\_2

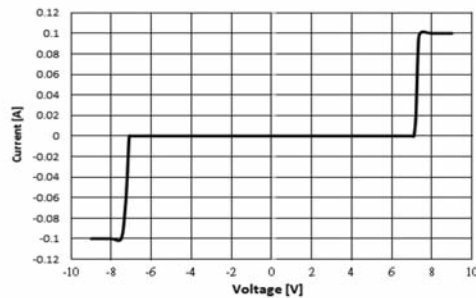

ESD Clamping of I/O\_1 to I/O\_2  
(+8kV Contact per IEC 61000-4-2)

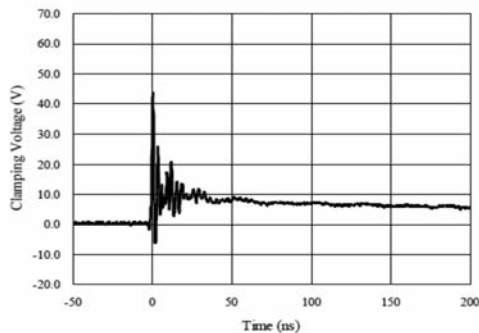

ESD Clamping of I/O\_1 to I/O\_2  
(-8kV Contact per IEC 61000-4-2)

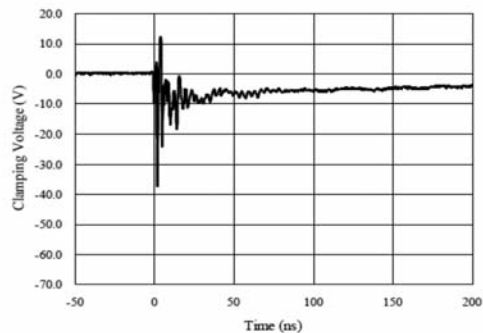

## Characteristic Curves - Typical

### GG040205100N2P (10PF)

TLP Measurement

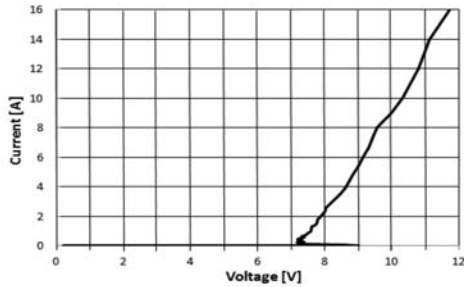

Voltage Sweeping of I/O\_1 to I/O\_2

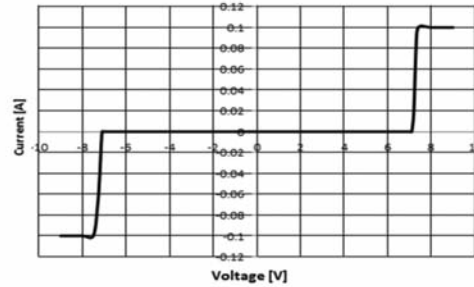

ESD Clamping of I/O\_1 to I/O\_2  
(+8kV Contact per IEC 61000-4-2)

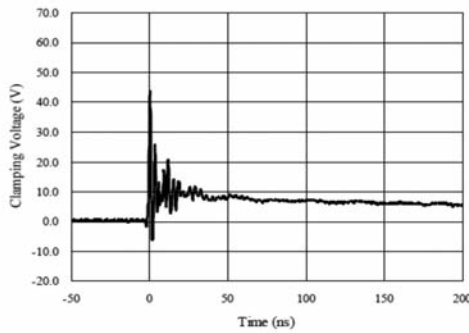

ESD Clamping of I/O\_1 to I/O\_2  
(-8kV Contact per IEC 61000-4-2)

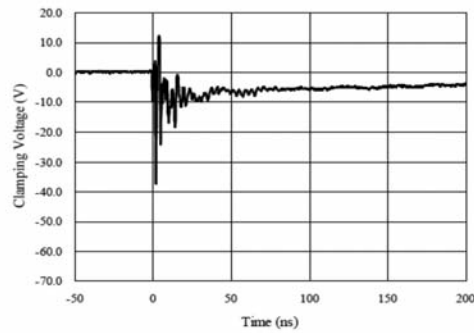

### GG040205170N2P (17PF)

TLP Measurement

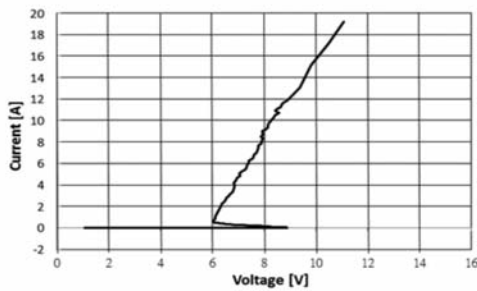

Voltage Sweeping of I/O\_1 to

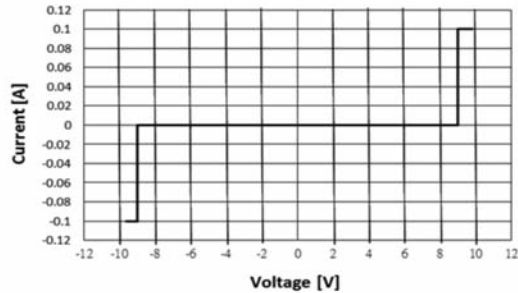

ESD Clamping of I/O\_1 to I/O\_2  
(+8kV Contact per IEC 61000-4-2)

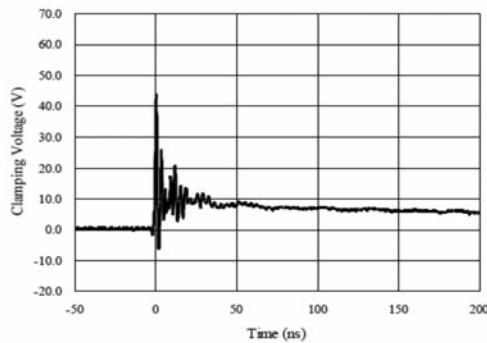

ESD Clamping of I/O\_1 to I/O\_2  
(-8kV Contact per IEC 61000-4-2)

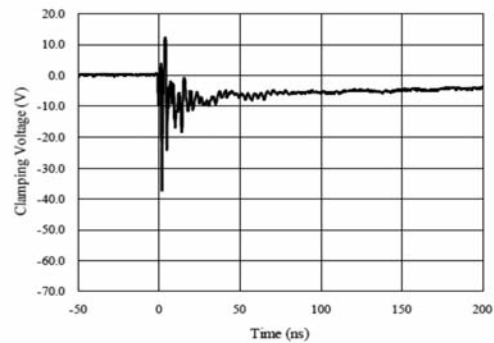

## TEMPERATURE DERATING

GG Series Temperature Derating Curve

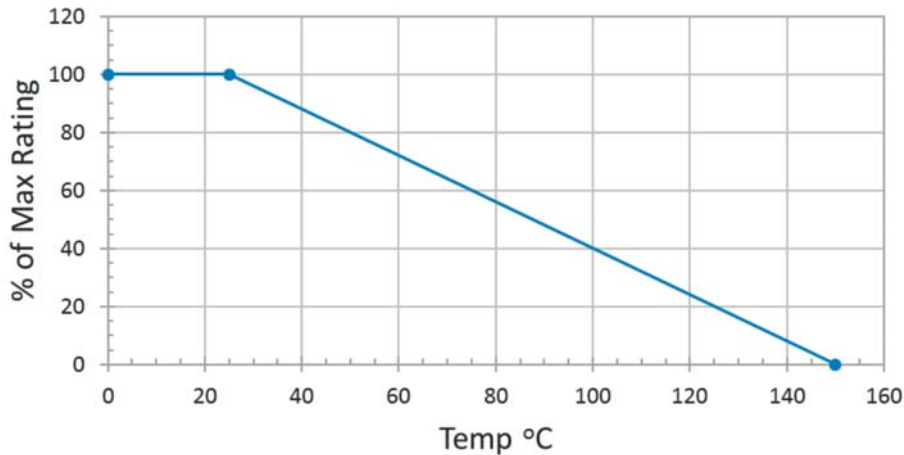

## DIMENSIONS

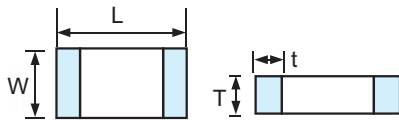

mm (inches)

| Size | Length (L)                     | Width (W)                      | Thick (T)                      | Termination (t)                |
|------|--------------------------------|--------------------------------|--------------------------------|--------------------------------|
| 0201 | 0.60 ± 0.03<br>(0.024 ± 0.001) | 0.30 ± 0.03<br>(0.012 ± 0.001) | 0.30 ± 0.03<br>(0.012 ± 0.001) | 0.15 ± 0.05<br>(0.006 ± 0.002) |
| 0402 | 1.00 ± 0.05<br>(0.039 ± 0.002) | 0.60 ± 0.05<br>(0.024 ± 0.002) | 0.50 ± 0.05<br>(0.020 ± 0.002) | 0.20 ± 0.05<br>(0.008 ± 0.002) |

## RECOMMENDED REFLOW SOLDER PAD

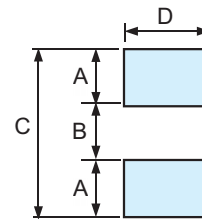

mm (inches)

| Size | A                              | B                              | C                              | D                                |
|------|--------------------------------|--------------------------------|--------------------------------|----------------------------------|
| 0201 | 0.25 ± 0.05<br>(0.010 ± 0.002) | 0.30 ± 0.05<br>(0.012 ± 0.002) | 0.80 ± 0.15<br>(0.031 ± 0.006) | 0.275 ± 0.025<br>(0.011 ± 0.001) |
| 0402 | 0.61 ± 0.05<br>(0.024 ± 0.002) | 0.51 ± 0.05<br>(0.020 ± 0.002) | 1.70 ± 0.05<br>(0.067 ± 0.002) | 0.51 ± 0.05<br>(0.020 ± 0.002)   |

## RECOMMENDED SOLDER REFLOW PROFILES

Recommended Reflow Profiles

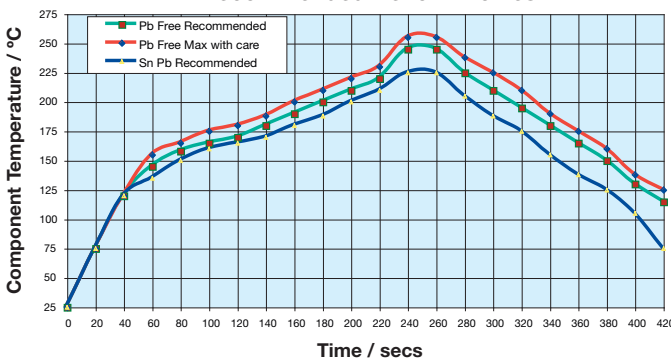

### Hand Soldering Cautions

In hand soldering of the Devices. Large temperature gradient between preheated the Devices and the tip of soldering iron may cause electrical failures and mechanical damages such as cracking or breaking of the devices. The soldering shall be carefully controlled and carried out so that the temperature gradient is kept minimum with following recommended conditions for hand soldering.

## RECOMMENDED SOLDERING CONDITION 1

- (1) Solder: **0.12~0.18mm** Thread solder (Sn96.5:Ag3.5) with soldering flux in the core Rosin-based and non-activated flux is recommended.
- (2) Preheating: The Devices shall be preheated so that Temperature Gradient between the devices and the tip of soldering iron is 150°C or below.
- (3) Soldering Iron: Rated Power of 20w max with 3mm soldering tip in diameter. Temperature of soldering iron tip **300°Cmax, 3-5sec** (The required amount of solder shall be melted in advance on the soldering tip.)
- (4) Cooling: After soldering. The Devices shall be cooled gradually at room ambient temperature.

## RECOMMENDED SOLDERING CONDITION 2 – WITHOUT PREHEATING

- (1) Temperature of soldering iron tip 300°Cmax, 3-5sec.
- (2) Solder iron tip shall not directly touch to Devices.
- (3) Solder iron tip shall be fully preheated before soldering while soldering iron tip to the external electrode of Devices.

## PACKAGING SPECIFICATION

- Carrier tape and transparent cover tape should be heat-sealed to carry the products, and the reel should be used to reel the carrier tape.
- The adhesion of the heat-sealed cover tape shall be 25~60 grams with nominal of 40 grams.
- Both the head and the end portion of the taping shall be empty for reel package and SMT auto-pickup machine. And a normal paper tape shall be connected in the head of taping for the operator to handle.

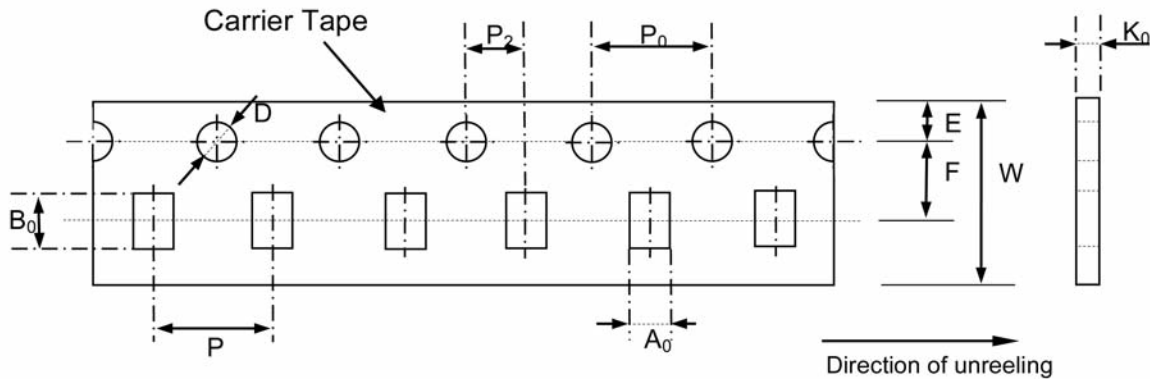

mm (inches)

| Case Size | $A_0$<br>$\pm 0.05$ (0.002) | $B_0$<br>$\pm 0.05$ (0.002) | $K_0$<br>$\pm 0.05$ (0.002) | $D$<br>$+0.10$ (0.004)<br>$-0.05$ (0.002) | $P$<br>$\pm 0.10$ (0.004) | $P_2$<br>$\pm 0.10$ (0.004) | $P_0$<br>$\pm 0.10$ (0.004) | $W$<br>$\pm 0.10$ (0.004) | $E$<br>$\pm 0.10$ (0.004) | $F$<br>$\pm 0.05$ (0.002) | Qty |
|-----------|-----------------------------|-----------------------------|-----------------------------|---|---------------------------|-----------------------------|-----------------------------|---------------------------|---------------------------|---------------------------|-----|
| 0201      | 0.37<br>(0.015)             | 0.67<br>(0.026)             | 0.50<br>(0.020)             | 1.50<br>(0.059)                           | 2.00<br>(0.079)           | 2.00<br>(0.079)             | 4.00<br>(0.157)             | 8.00<br>(0.315)           | 1.75<br>(0.069)           | 3.50<br>(0.138)           | 15K |
| 0402      | 0.70<br>(0.028)             | 1.12<br>(0.044)             | 0.60<br>(0.024)             | 1.55<br>(0.061)                           | 2.00<br>(0.079)           | 2.00<br>(0.079)             | 4.00<br>(0.157)             | 8.00<br>(0.315)           | 1.75<br>(0.069)           | 3.50<br>(0.138)           | 10k |

## REEL DIMENSIONS

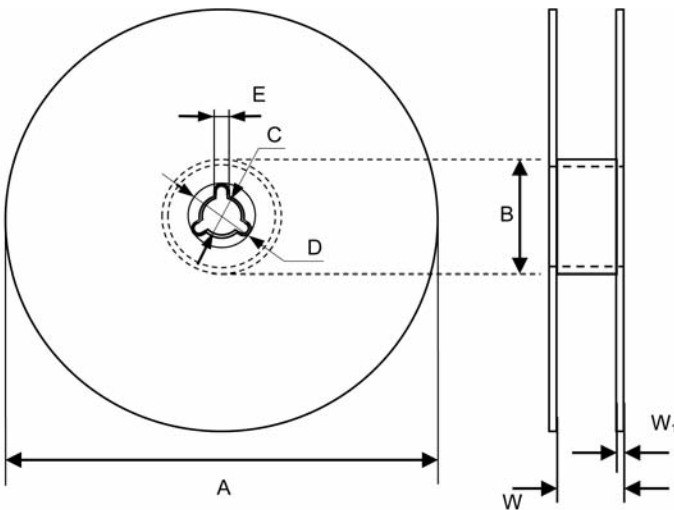

mm (inches)

| Reel Size | $A$                                      | $B$                                     | $C$                                     | $D$                                     | $E$                                    | $W$                                     | $W_1$                                   |
|-----------|--|---|---|---|--|---|---|
| 7"        | $178.0 \pm 1.0$<br>( $7.008 \pm 0.039$ ) | $60.0 \pm 0.5$<br>( $2.362 \pm 0.020$ ) | $13.0 \pm 0.2$<br>( $0.512 \pm 0.008$ ) | $21.0 \pm 0.2$<br>( $0.827 \pm 0.008$ ) | $2.0 \pm 0.5$<br>( $0.079 \pm 0.020$ ) | $9.0 \pm 0.50$<br>( $0.354 \pm 0.020$ ) | $1.5 \pm 0.15$<br>( $0.059 \pm 0.006$ ) |

## AMERICAS

AVX Greenville, SC  
Tel: 864-967-2150

## EUROPE

AVX Limited, England  
Tel: +44-1252-770000

AVX S.A.S., France  
Tel: +33-1-69-18-46-00

AVX GmbH, Germany  
Tel: +49-0811-95949-0

AVX SRL, Italy  
Tel: +39-02-614-571

AVX Czech Republic  
Tel: +420-57-57-57-521

AVX/ELCO UK  
Tel: +44-1638-675000

ELCO Europe GmbH  
Tel: +49-2741-299-0

AVX S.A., Spain  
Tel: +34-91-63-97-197

AVX Benelux  
Tel: +31-187-489-337

## ASIA-PACIFIC

AVX/Kyocera (S) Pte Ltd.,  
Singapore  
Tel: +65-6286-7555

AVX/Kyocera, Asia, Ltd.,  
Hong Kong  
Tel: +852-2363-3303

AVX/Kyocera Yuhan Hoesa,  
South Korea  
Tel: +82-2785-6504

AVX/Kyocera HK Ltd.,  
Taiwan  
Tel: +886-2-2656-0258

AVX/Kyocera (M) Sdn Bhd,  
Malaysia  
Tel: +60-4228-1190

AVX/Kyocera International  
Trading Co. Ltd.,  
Shanghai  
Tel: +86-21-3255 1933

AVX/Kyocera Asia Ltd.,  
Shenzen  
Tel: +86-755-3336-0615

AVX/Kyocera International  
Trading Co. Ltd.,  
Beijing  
Tel: +86-10-6588-3528

AVX/Kyocera India  
Liaison Office  
Tel: +91-80-6450-0715

## ASIA-KED

(KYOCERA Electronic Devices)

KED Hong Kong Ltd.  
Tel: +852-2305-1080/1223

KED Hong Kong Ltd.  
Shenzen  
Tel: +86-755-3398-9600

KED Company Ltd.  
Shanghai  
Tel: +86-21-3255-1833

KED Hong Kong Ltd.  
Beijing  
Tel: +86-10-5869-4655

KED Taiwan Ltd.  
Tel: +886-2-2950-0268

KED Korea Yuhan Hoesa,  
South Korea  
Tel: +82-2-783-3604/6126

KED (S) Pte Ltd.  
Singapore  
Tel: +65-6509-0328

Kyocera Corporation  
Japan  
Tel: +81-75-604-3449

### Contact:

