

### Intellimod™ L-Series Three Phase IGBT Inverter 450 Amperes/1200 Volts

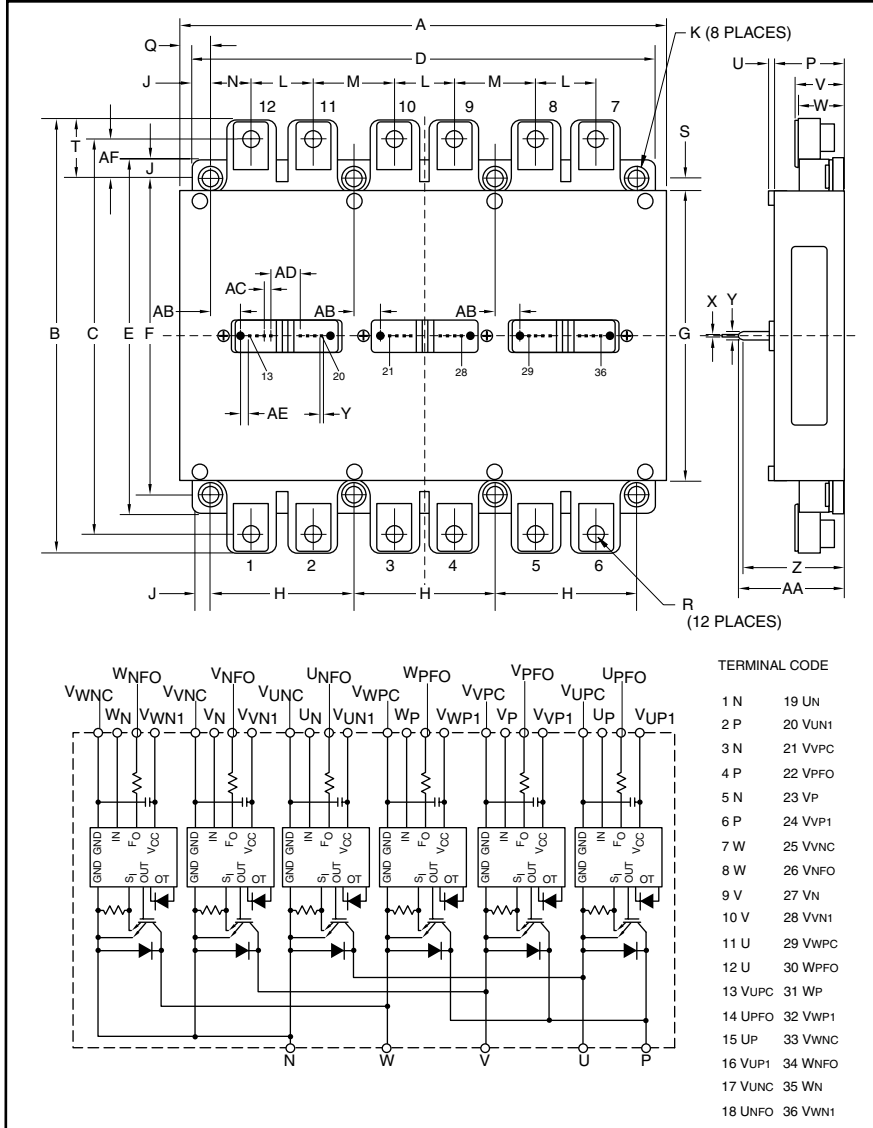

Outline Drawing and Circuit Diagram

Dimensions	Inches	Millimeters
A	6.77	172.0
B	5.90	150.0
C	5.39	137.0
D	6.38	162.0
E	4.84	123.0
F	4.33	110.0
G	3.90	99.0
H	1.97	50.0
J	0.236	6.0
K	5.5 Metric	M5.5
L	0.866	22.0
M	1.10	28.0
N	0.55	14.0
P	0.945	24.0
Q	0.43	11.0
R	M6 Metric	M6

Dimensions	Inches	Millimeters
S	0.217	5.5
T	0.79	20.0
U	0.08	2.0
V	0.67	17.0
W	0.62	15.8
X	0.025 Sq.	Sq. 0.64
Y	0.1 Dia	Dia. 2.5
Z	1.40	35.5
AA	1.44	36.6
AB	0.36	9.08
AC	0.10	2.54
AD	0.40	10.16
AE	0.127	3.22
AF	0.53	13.5
AG	0.256	6.5

#### Description:

Powerex Intellimod™ Intelligent Power Modules are isolated base modules designed for power switching applications operating at frequencies to 20kHz. Built-in control circuits provide optimum gate drive and protection for the IGBT and free-wheel diode power devices.

#### Features:

- Complete Output Power Circuit
- Gate Drive Circuit
- Protection Logic
  - Short Circuit
  - Over Temperature
  - Using On-chip Temperature Sensing
  - Under Voltage
- Low Loss Using 5th Generation IGBT Chip
- Low EMI/RFI

#### Applications:

- Inverters
- UPS
- Motion/Servo Control
- Power Supplies

#### Ordering Information:

Example: Select the complete part number from the table below -i.e. PM450CLA120 is a 1200V, 450 Ampere Intellimod™ Intelligent Power Module.

Type	Current Rating Amperes	V <sub>CES</sub> Volts (x 10)
PM	450	120



Powerex, Inc., 200 E. Hillis Street, Youngwood, Pennsylvania 15697-1800 (724) 925-7272

**PM450CLA120**  
**Intellimod™ L-Series**  
**Three Phase IGBT Inverter**  
**450 Amperes/1200 Volts**

**Absolute Maximum Ratings,  $T_j = 25^\circ\text{C}$  unless otherwise specified**

Characteristics	Symbol	PM450CLA120	Units
Power Device Junction Temperature	$T_j$	-20 to 150	$^\circ\text{C}$
Storage Temperature	$T_{\text{stg}}$	-40 to 125	$^\circ\text{C}$
Mounting Torque, M5 Mounting Screws	—	31	in-lb
Mounting Torque, M6 Main Terminal Screws	—	40	in-lb
Module Weight (Typical)	—	1250	Grams
Supply Voltage, Surge (Applied between P - N)	$V_{\text{CC(surge)}}$	1000	Volts
Self-protection Supply Voltage Limit (Short Circuit protection Capability)*	$V_{\text{CC(prot.)}}$	800	Volts
Isolation Voltage, AC 1 minute, 60Hz Sinusoidal	$V_{\text{ISO}}$	2500	Volts

\* $V_D = 13.5 - 16.5\text{V}$ , Inverter Part,  $T_j = 125^\circ\text{C}$

**IGBT Inverter Sector**

Collector-Emitter Voltage ( $V_D = 15\text{V}$ , $V_{\text{CIN}} = 15\text{V}$ )	$V_{\text{CES}}$	1200	Volts
Collector Current ( $T_C = 25^\circ\text{C}$ )	$\pm I_C$	450	Amperes
Peak Collector Current ( $T_C = 25^\circ\text{C}$ )	$\pm I_{\text{CP}}$	900	Amperes
Collector Dissipation ( $T_C = 25^\circ\text{C}$ )	$P_C$	2500	Watts

**Control Sector**

Supply Voltage (Applied between $V_{\text{UP1}}-V_{\text{UPC}}$ , $V_{\text{VP1}}-V_{\text{VPC}}$ , $V_{\text{WP1}}-V_{\text{WPC}}$ , $V_{\text{UN1}}-V_{\text{UNC}}$ , $V_{\text{WN1}}-V_{\text{WNC}}$ , $V_{\text{N1}}-V_{\text{NC}}$ )	$V_D$	20	Volts
Input Voltage (Applied between $U_P-V_{\text{UPC}}$ , $V_P-V_{\text{VPC}}$ , $W_P-V_{\text{WPC}}$ , $U_N-V_{\text{UNC}}$ , $V_N-V_{\text{VNC}}$ , $W_N-V_{\text{WNC}}$ )	$V_{\text{CIN}}$	20	Volts
Fault Output Supply Voltage (Applied between $U_{\text{PFO}}-V_{\text{UPC}}$ , $V_{\text{PFO}}-V_{\text{VPC}}$ , $W_{\text{PFO}}-V_{\text{WPC}}$ , $U_{\text{NFO}}-V_{\text{UNC}}$ , $V_{\text{NFO}}-V_{\text{VNC}}$ , $W_{\text{NFO}}-V_{\text{WNC}}$ )	$V_{\text{FO}}$	20	Volts
Fault Output Sink Current at $U_{\text{PFO}}$ , $V_{\text{PFO}}$ , $W_{\text{PFO}}$ , $U_{\text{NFO}}$ , $V_{\text{NFO}}$ , $W_{\text{NFO}}$ Terminals	$I_{\text{FO}}$	20	mA

**PM450CLA120**  
**Intellimod™ L-Series**  
**Three Phase IGBT Inverter**  
**450 Amperes/1200 Volts**

**Electrical and Mechanical Characteristics,  $T_j = 25^\circ\text{C}$  unless otherwise specified**

Characteristics	Symbol	Test Conditions	Min.	Typ.	Max.	Units
<b>IGBT Inverter Sector</b>						
Collector-Emitter Cutoff Current	$I_{CES}$	$V_{CE} = V_{CES}, V_{CIN} = 15V, T_j = 25^\circ\text{C}$	—	—	1.0	mA
		$V_{CE} = V_{CES}, V_{CIN} = 15V, T_j = 125^\circ\text{C}$	—	—	10	mA
Diode Forward Voltage	$V_{EC}$	$-I_C = 450A, V_{CIN} = 15V, V_D = 15V$	—	2.8	3.9	Volts
Collector-Emitter Saturation Voltage	$V_{CE(sat)}$	$V_D = 15V, V_{CIN} = 0V, I_C = 450A, T_j = 25^\circ\text{C}$	—	1.8	2.3	Volts
		$V_D = 15V, V_{CIN} = 0V, I_C = 450A, T_j = 125^\circ\text{C}$	—	1.9	2.4	Volts
Inductive Load Switching Times	$t_{on}$		0.5	1.0	2.5	$\mu\text{s}$
	$t_{rr}$	$V_D = 15V, V_{CIN} = 0 \leftrightarrow 15V$	—	0.5	0.8	$\mu\text{s}$
	$t_{C(on)}$	$V_{CC} = 600V, I_C = 450A$	—	0.4	1.0	$\mu\text{s}$
	$t_{off}$	$T_j = 125^\circ\text{C}$	—	2.3	3.5	$\mu\text{s}$
	$t_{C(off)}$		—	0.7	1.2	$\mu\text{s}$
<b>Control Sector</b>						
Short Circuit Trip Level	SC	$-20^\circ\text{C} \leq T_j \leq 125^\circ\text{C}, V_D = 15V$	900	—	—	Amperes
Short Circuit Current Delay Time	$t_{off(SC)}$	$V_D = 15V$	—	0.2	—	$\mu\text{s}$
Over Temperature Protection	OT	Trip Level	135	145	—	$^\circ\text{C}$
(Detect $T_j$ of IGBT Chip)	$OT_R$	Reset Level	—	125	—	$^\circ\text{C}$
Supply Circuit Under-voltage Protection ( $-20 \leq T_j \leq 125^\circ\text{C}$ )	UV	Trip Level	11.5	12.0	12.5	Volts
	$UV_R$	Reset Level	—	12.5	—	Volts
Circuit Current	$I_D$	Upper Arm $V_D = 15V, V_{CIN} = 15V$	—	20	27	mA
		Lower Arm $V_D = 15V, V_{CIN} = 15V$	—	20	27	mA
Input ON Threshold Voltage	$V_{th(on)}$	Applied between $U_P-V_{UPC}, V_P-V_{VPC}$	1.2	1.5	1.8	Volts
Input OFF Threshold Voltage	$V_{th(off)}$	$W_P-V_{WPC}, U_N-V_{UNC}, V_N-V_{VNC}, W_N-V_{WNC}$	1.7	2.0	2.3	Volts
Fault Output Current*	$I_{FO(H)}$	$V_D = 15V, V_{FO} = 15V$	—	—	0.01	mA
	$I_{FO(L)}$	$V_D = 15V, V_{FO} = 15V$	—	10	15	mA
Fault Output Pulse Width*	$t_{FO}$	$V_D = 15V$	1.0	1.8	—	ms

\*Fault output is given only when the internal SC, OT and UV protection of either upper or lower arms is tripped.



Powerex, Inc., 200 E. Hillis Street, Youngwood, Pennsylvania 15697-1800 (724) 925-7272

**PM450CLA120**  
**Intellimod™ L-Series**  
**Three Phase IGBT Inverter**  
**450 Amperes/1200 Volts**

### Thermal Characteristics

Characteristics	Symbol	Test Conditions	Min.	Typ.	Max.	Units
Junction to Case Thermal Resistance	$R_{th(j-c)Q}$	IGBT (Per 1/6 Module) (Note 1)	—	—	0.05	°C/Watt
	$R_{th(j-c)D}$	FWDi (Per 1/6 Module) (Note 1)	—	—	0.09	°C/Watt
Contact Thermal Resistance	$R_{th(c-f)}$	Case to Fin Per Module, Thermal Grease Applied	—	—	0.014	°C/Watt

Note 1: If you use this value,  $R_{th(t-a)}$  should be measured just under the chips.

### Recommended Conditions for Use

Characteristic	Symbol	Condition	Value	Units
Supply Voltage	$V_{CC}$	Applied across P-N Terminals	$\leq 800$	Volts
Control Supply Voltage*	$V_D$	Applied between $V_{UP1}-V_{UPC}$ , $V_{VP1}-V_{VPC}$ , $V_{WP1}-V_{WPC}$ , $V_{UN1}-V_{UNC}$ , $V_{VN1}-V_{VNC}$ , $V_{WN1}-V_{WNC}$	$15.0 \pm 1.5$	Volts
Input ON Voltage	$V_{CIN(on)}$	Applied between $U_P-V_{UPC}$ , $U_N-V_{UNC}$ ,	$\leq 0.8$	Volts
Input OFF Voltage	$V_{CIN(off)}$	$V_N-V_{VNC}$ , $V_P-V_{VPC}$ , $W_N-V_{WNC}$ , $W_P-V_{WPC}$	$\geq 9.0$	Volts
PWM Input Frequency	$f_{PWM}$	—	$\leq 20$	kHz
Arm Shoot-through Blocking Time	$t_{DEAD}$	Input Signal	$\geq 3.0$	$\mu s$

\*With ripple satisfying the following conditions:  $dv/dt$  swing  $\leq \pm 5V/\mu s$ , Variation  $\leq 2V$  peak to peak.



Powerex, Inc., 200 E. Hillis Street, Youngwood, Pennsylvania 15697-1800 (724) 925-7272

**PM450CLA120**  
**Intellimod™ L-Series**  
**Three Phase IGBT Inverter**  
**450 Amperes/1200 Volts**

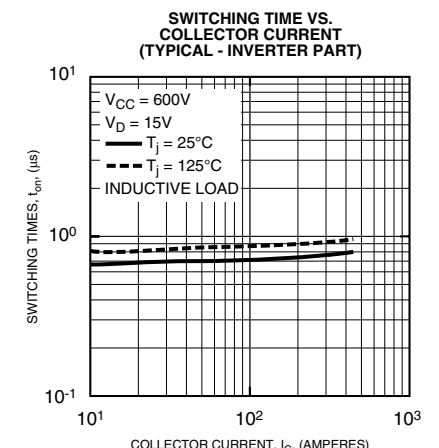
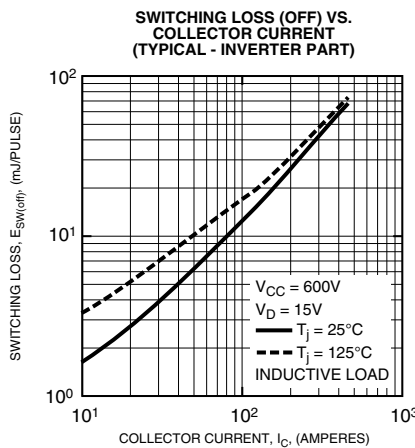
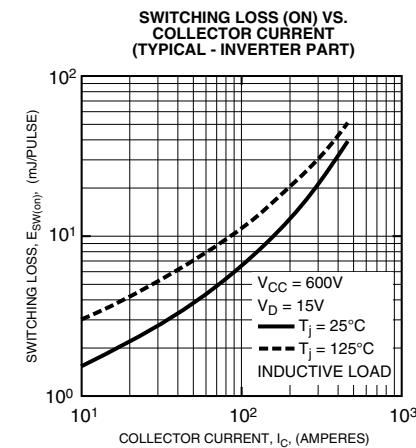
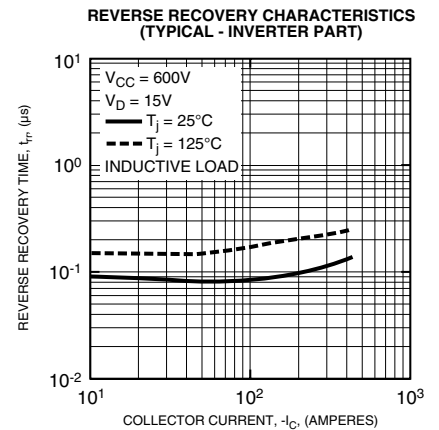
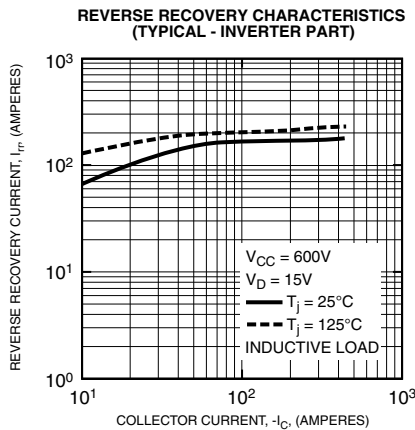
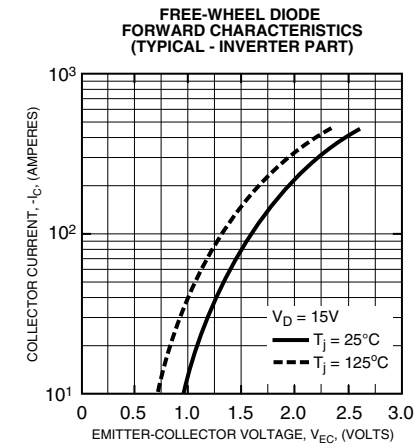
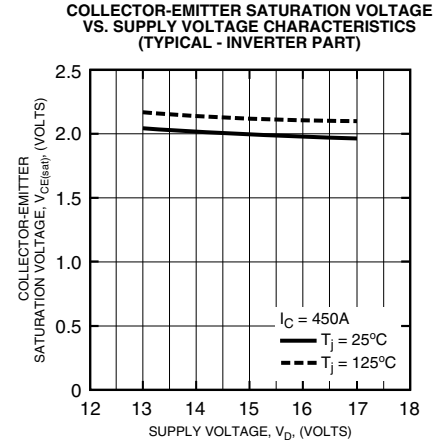
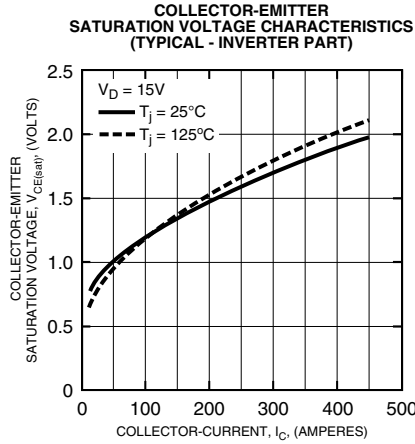
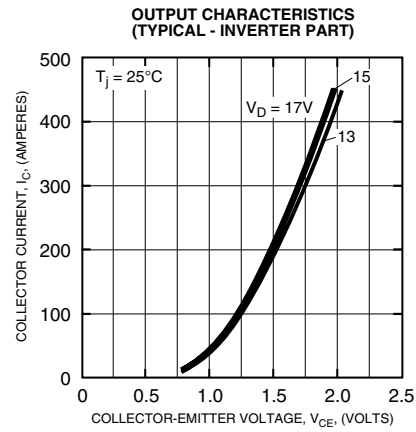



Powerex, Inc., 200 E. Hillis Street, Youngwood, Pennsylvania 15697-1800 (724) 925-7272

**PM450CLA120**  
**Intellimod™ L-Series**  
**Three Phase IGBT Inverter**  
**450 Amperes/1200 Volts**

