

RELIABILITY TEST DATA

HIGH VOLTAGE CHIP MONOLITHIC CERAMIC CAPACITOR

MURATA P N : GA242QR7E2102MW01L

	PAGE
1. INITIAL (Cap., D.F., I.R.)	... 1
2. TEMPERATURE CHARACTERISTIC	... 2
3. ADHESIVE STRENGTH of TERMINATION	... 2
4. DEFLECTION	... 3
5. SOLDERABILITY of TERMINATION	... 3
6. HUMIDITY INSULATION	... 4
7. RESISTANCE to SOLDERING HEAT	... 5
8. TEMPERATURE CYCLE	... 6
9. HUMIDITY	... 7
10. LIFE (HIGH TEMPERATURE LOADING)	... 8
11. HUMIDITY LOADING	... 9

1. INITIAL (CAP., D.F., I.R.)

Condition : (Cap., D.F.) 1.0 kHz, 1.0 V(r.m.s.)
 (I.R.) DC500 V, 60 s
 (Temp.) 20 ° C

Sample Qty. : 30 pcs.

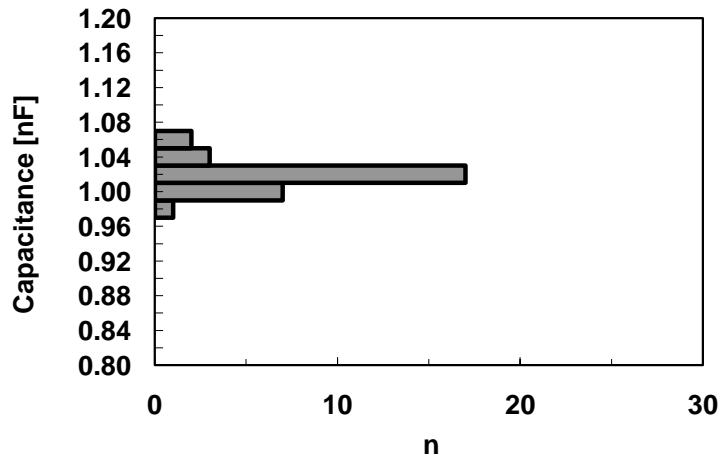

Spec.

Within 1 nF $\pm 20\%$
 (0.8 to 1.2 nF)

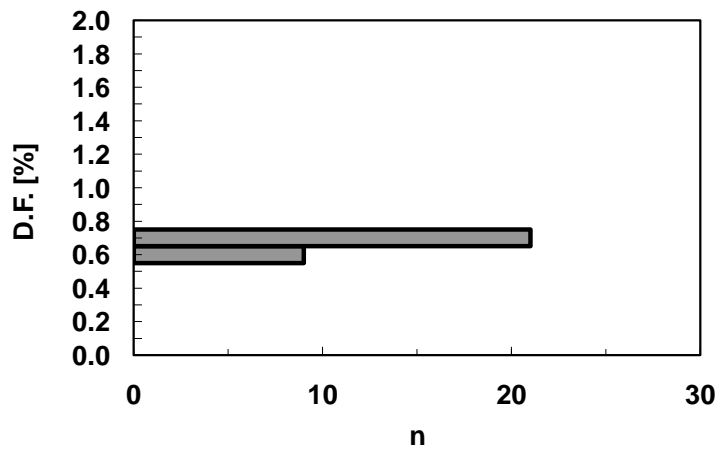

Spec.

2.5 % max.

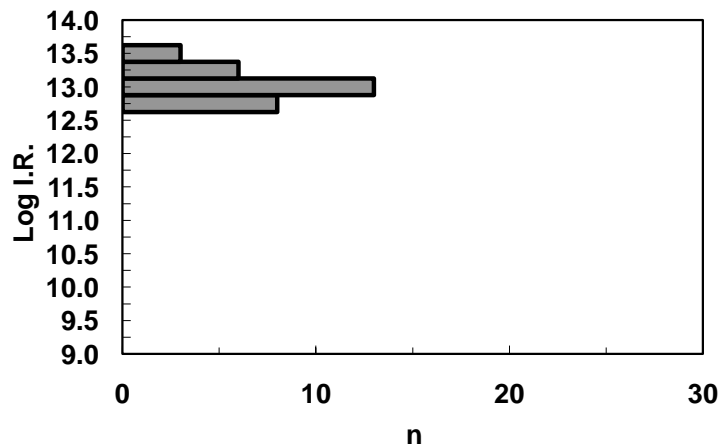

Spec.

2000 M Ω min.
 (Log I.R. : 9.3)

2. TEMPERATURE CHARACTERISTIC

Condition : 1.0 kHz, 1.0 V(r.m.s.)

Pre-treatment ... Store at 150° C for 1 h, and then, place at room condition for 24 h.

Specification : ±15 % (Temp. Range : -55 to 125 ° C, Reference Temp. : 25 ° C)

Sample Qty. : 5 pcs.

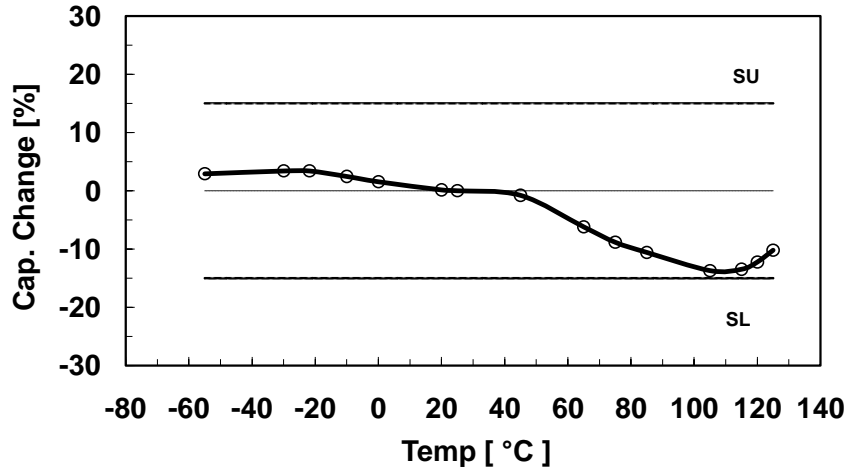

3. ADHESIVE STRENGTH of TERMINATION

Condition : Solder the capacitor to the glass epoxy board shown in Fig.1, using an eutectic solder. Then apply 10N force in the direction of the arrow on Fig.1.

Specification : No removal of the external electrode or other defects.

Sample Qty. : 10 pcs.

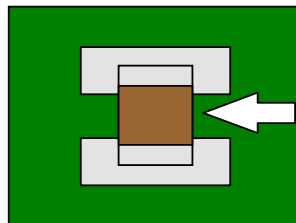

1 mm/s
10 N, 10 s.

Glass Epoxy Board

Fig.1

No.	RESULT
1	OK
2	OK
3	OK
4	OK
5	OK
6	OK
7	OK
8	OK
9	OK
10	OK

4. DEFLECTION

Condition : Solder the capacitor to the glass epoxy board shown in Fig.2, using an eutectic solder. Then apply the force in the direction of the arrow on Fig.3, for 5 s.

Sample Qty. : 10 pcs.

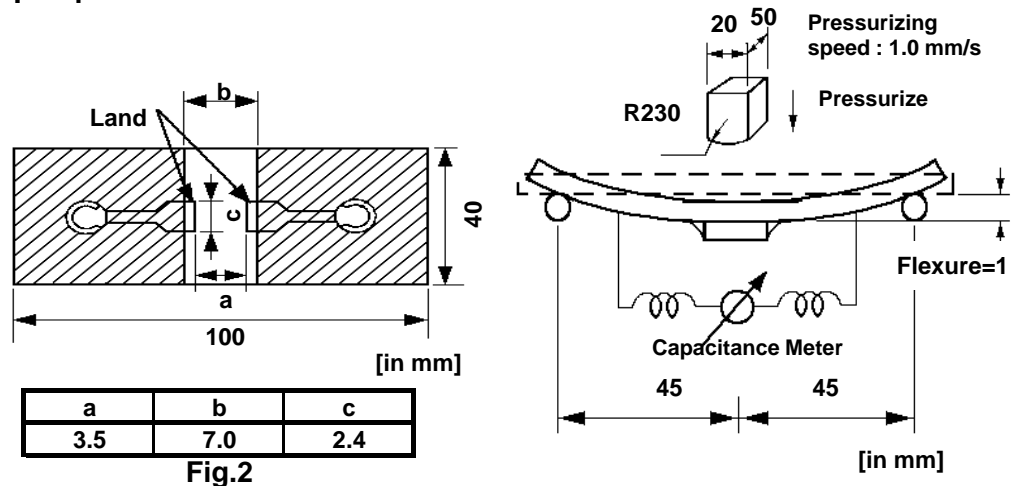

No.	RESULT
1	OK
2	OK
3	OK
4	OK
5	OK
6	OK
7	OK
8	OK
9	OK
10	OK

5. SOLDERABILITY of TERMINATION

Condition : Immerse the capacitor in ethanol(JIS-K-8101) and rosin(JIS-K-5902)(25% rosin in weight proportion) solution. And then, immerse in eutectic solder solution at 235 degree C for 2 s.

Specification : Solder covers more than 75% area of the external electrode, evenly and continuously.

Sample Qty. : 10 pcs.

No.	RESULT
1	OK
2	OK
3	OK
4	OK
5	OK
6	OK
7	OK
8	OK
9	OK
10	OK

6. HUMIDITY INSURATION

Condition : Store the 5 cycles of 40° C , 98% for 8 h and room condition for 16 h.

Sample Qty. : 20 pcs.

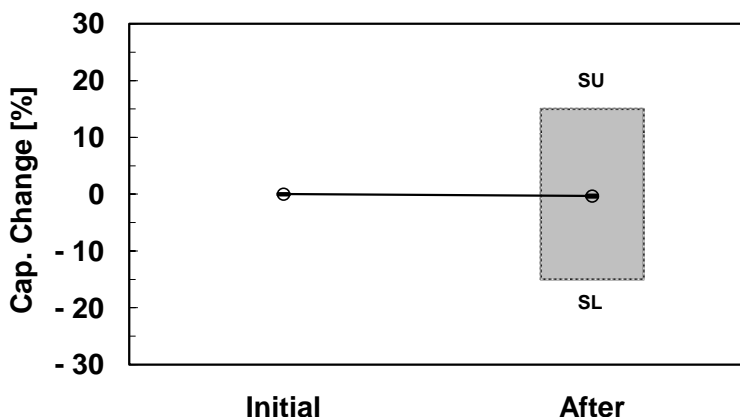

Spec.
Within ±15 %

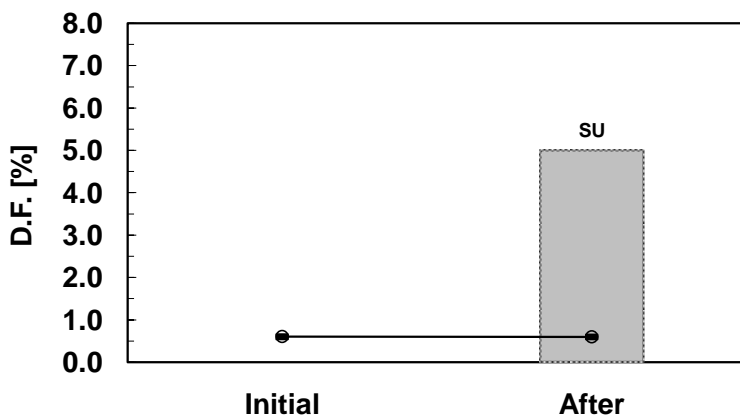

Spec.
5 % max.

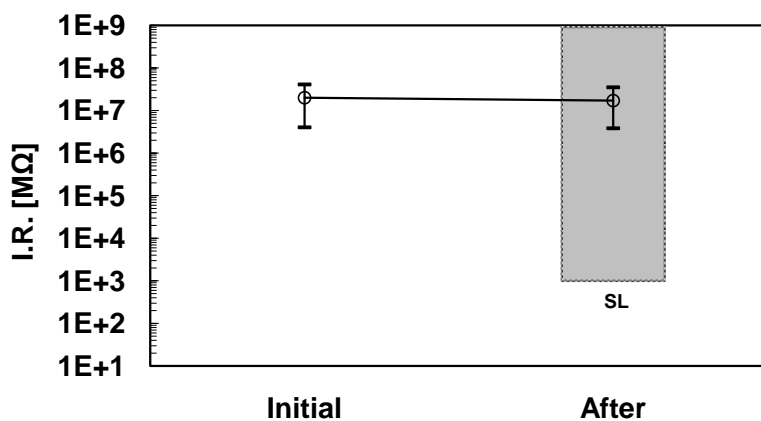

Spec.
1000 MΩ min.

Room Condition

Temperature : between 15 to 35° C
 Humidity : between 45 to 75 %
 Atm. pressure : between 86 to 106 kPa

7. RESISTANCE to SOLDERING HEAT

Condition : Preheat the capacitor between 100 and 120° C for 1 min, and then, between 170 and 200° C for 1 min. Immerse the capacitor in eutectic solder solution at 260° C for 10 s.

Pre-treatment ... Store at 150° C for 1 h, and then, place at room condition for 24 h.

Post-treatment... Place at room condition for 24 h.

Sample Qty. : 20 pcs.

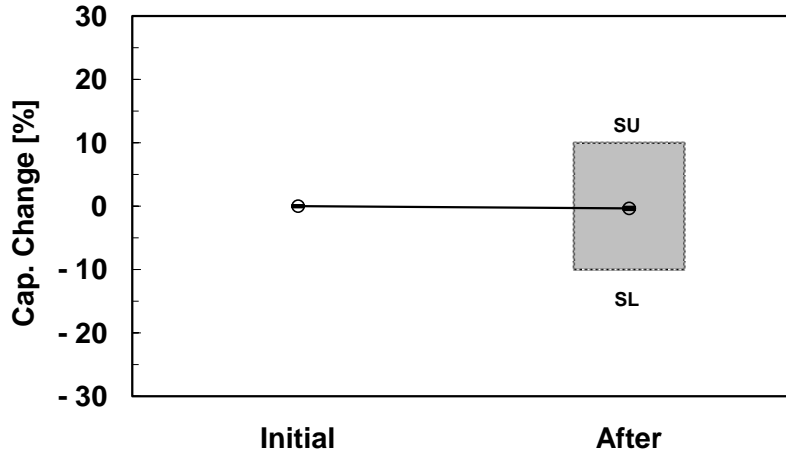

Spec.
Within $\pm 10\%$

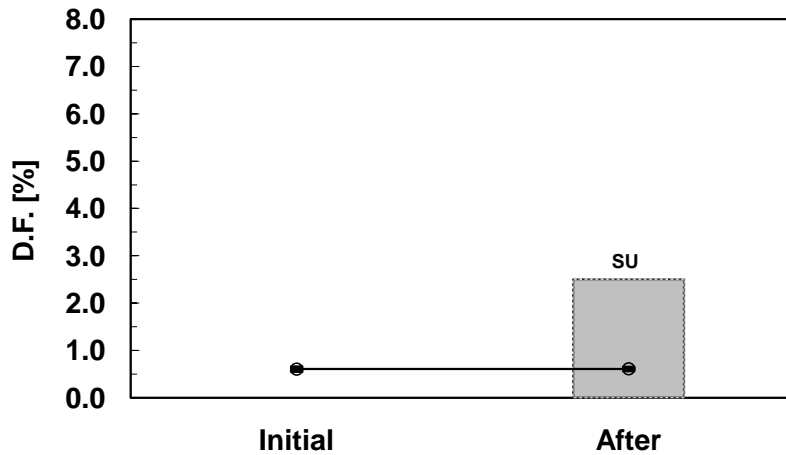

Spec.
2.5 % max.

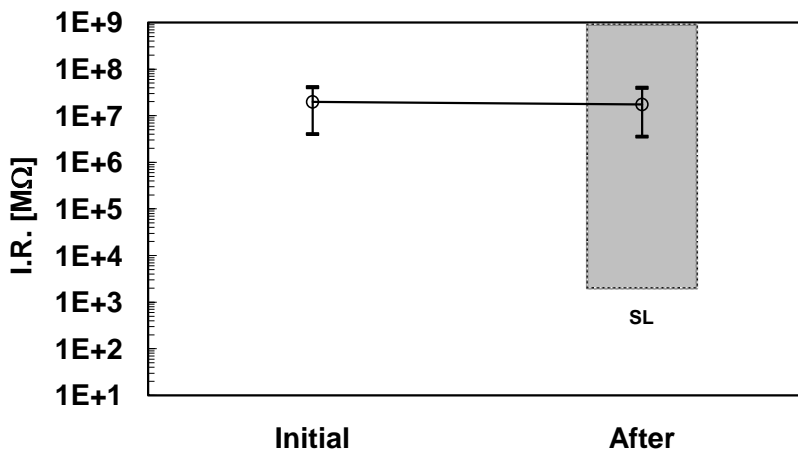

Spec.
2000 MΩ min.

8. TEMPERATURE CYCLE

Condition : Store the 5 cycles of the 4 steps heat treatment of following Table.

Step	1	2	3	4
Temp.[°C]	-25	20	+85	20
Time[min.]	30	2	30	2

Pre-treatment ... Store at 150 ° C for 1 h, and then, place at room condition for 24 h.
 Post-treatment... Place at room condition for 24 h.

Sample Qty. : 10 pcs.

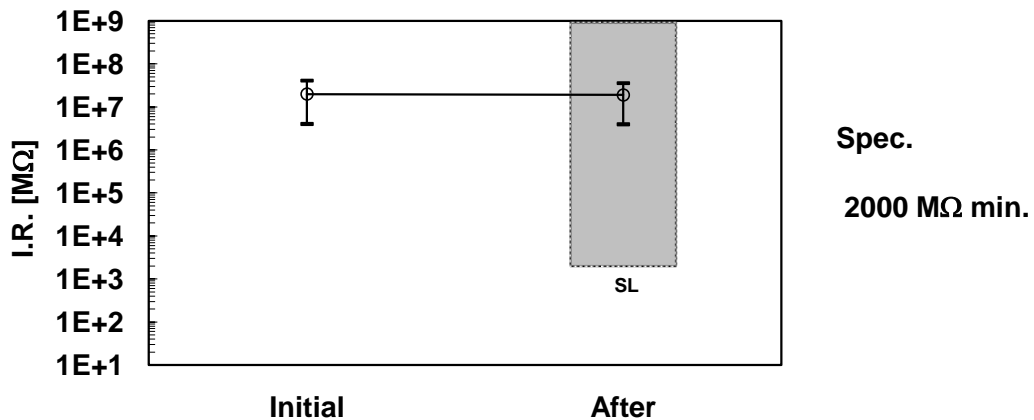
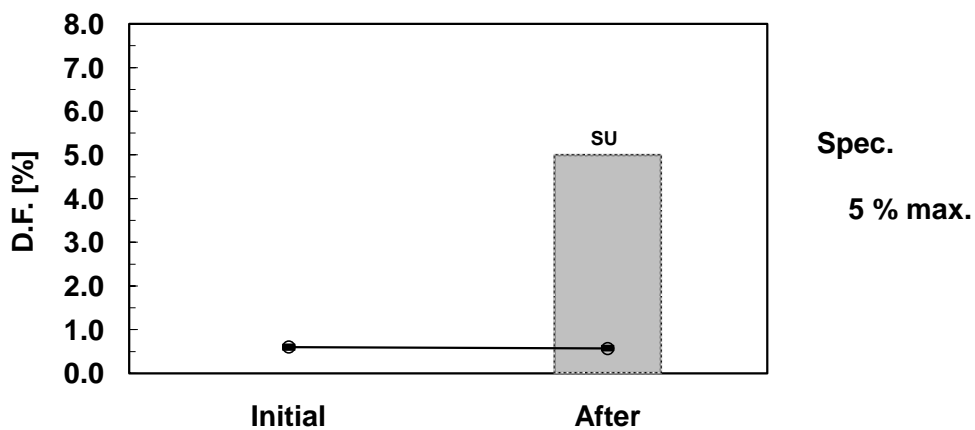
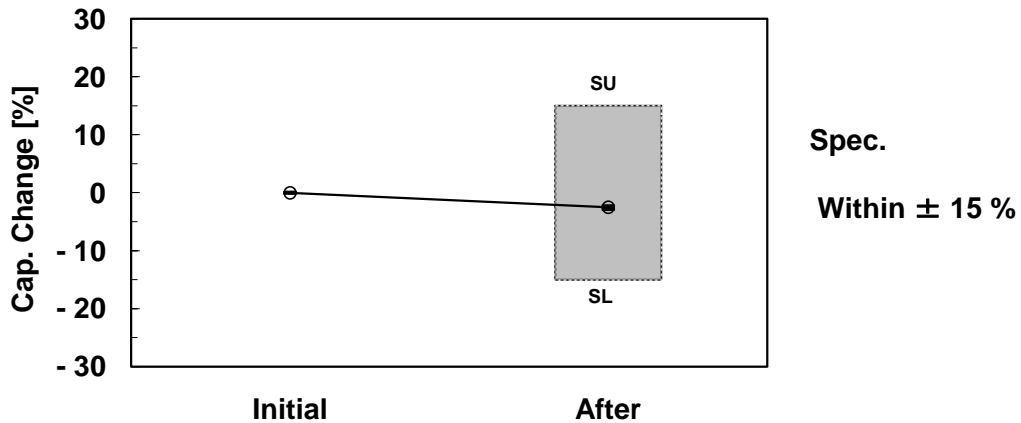

9. HUMIDITY (STEADY STATE)

Condition : Temperature ... 40 ° C
 Relative Humidity ... 95 %
 Duration ... 500 h

Pre-treatment ... Store at 150 ° C for 1 h, and then,
 place at room condition for 24 h.
 Post-treatment... Place at room condition for 24 h.

Sample Qty. : 20 pcs.

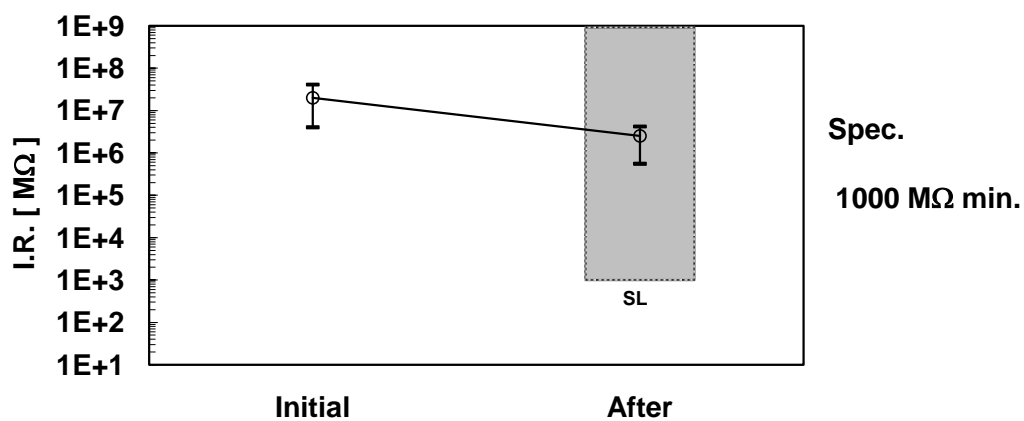
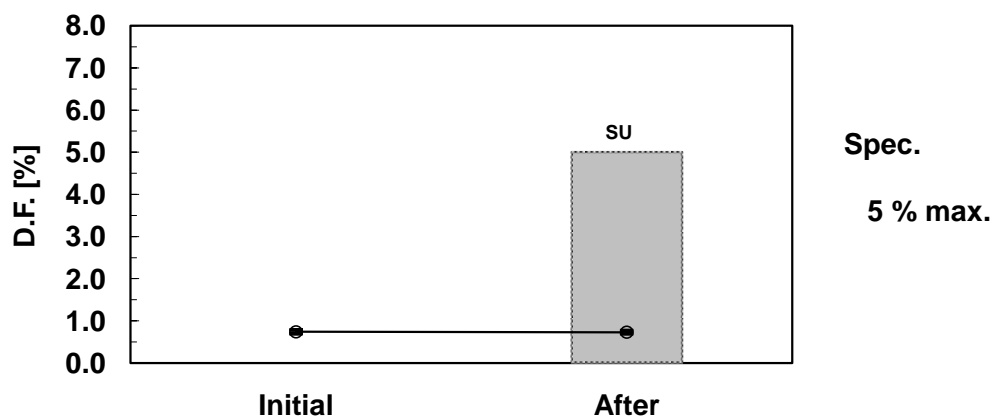
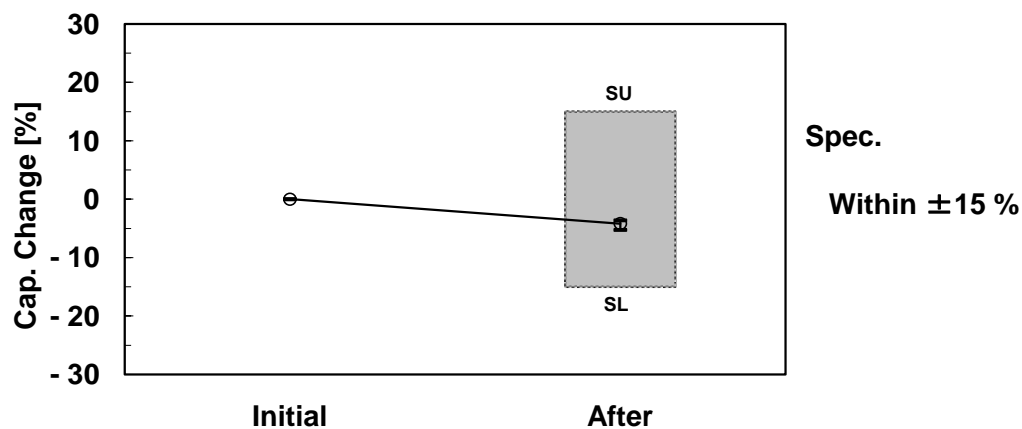

10. LIFE (HIGH TEMPERATURE LOADING)

Condition : Temperature ... 85 ° C
 Load ... AC500V(r.m.s.) (Once each hour the voltage is increased to AC1kV(r.m.s) for 0.1s)
 Duration ... 1500 h

Pre-treatment ... Give AC500V(r.m.s.) at 85° C for 1 h, and then, place at room condition for 24 h.

Post-treatment... Place at room condition for 24 h.

Sample Qty. : 20 pcs.

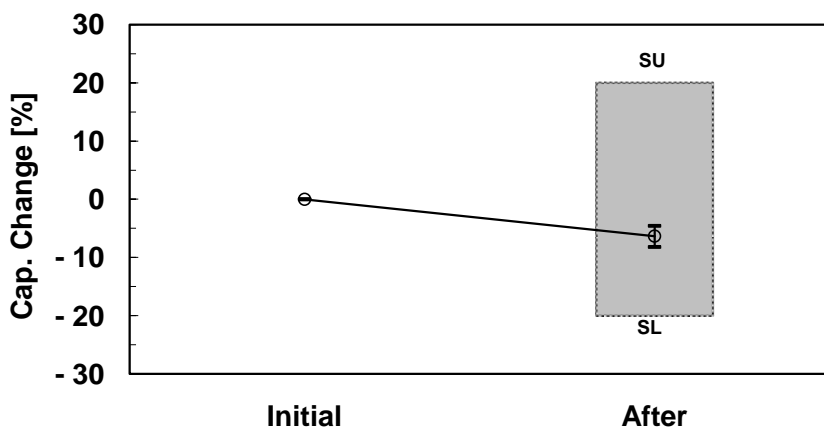

Spec.
 Within $\pm 20\%$

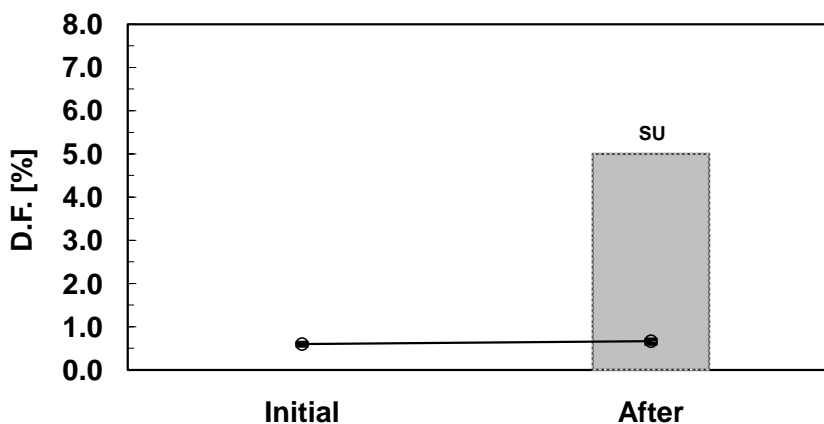

Spec.
 5 % max.

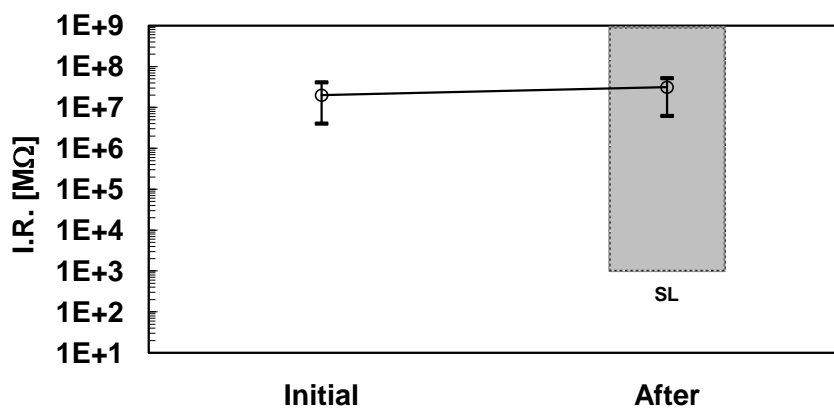

Spec.
 1000 MΩ min.

11. HUMIDITY LOADING

Condition : Temperature ... 40 ° C
 Relative Humidity ... 95 %
 Load ... Rated Voltage
 Duration ... 500 h
 Pre-treatment ... Give the rated voltage at 40° C for 1 h, and then,
 place at room condition for 24 h.
 Post-treatment... Place at room condition for 24 h.

Sample Qty. : 20 pcs.

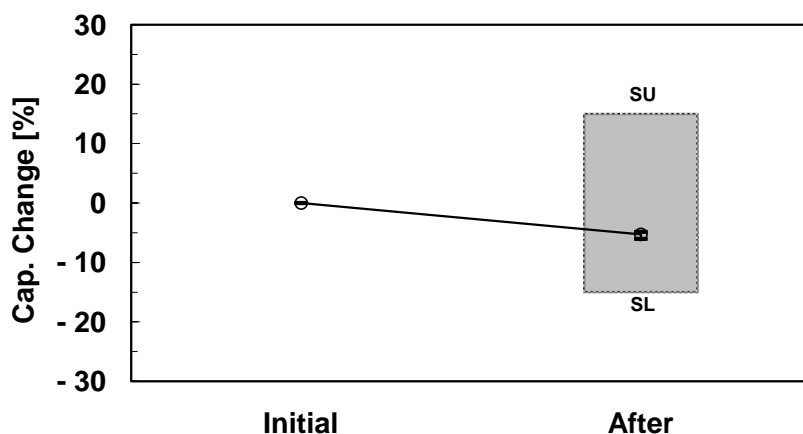

Spec.
 Within ±15 %

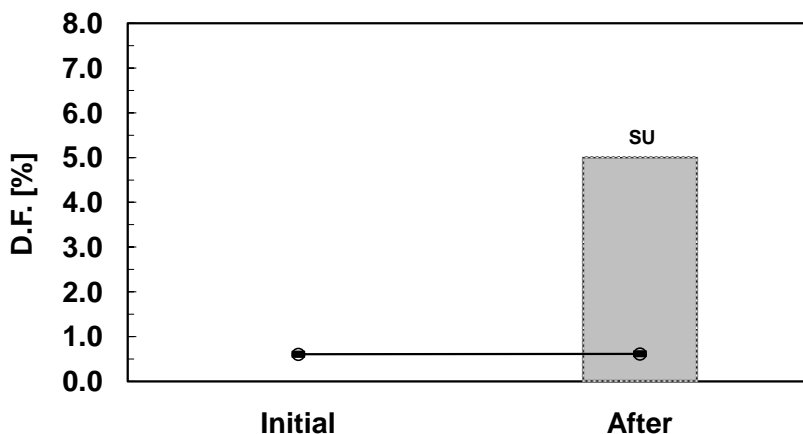

Spec.
 5 % max.

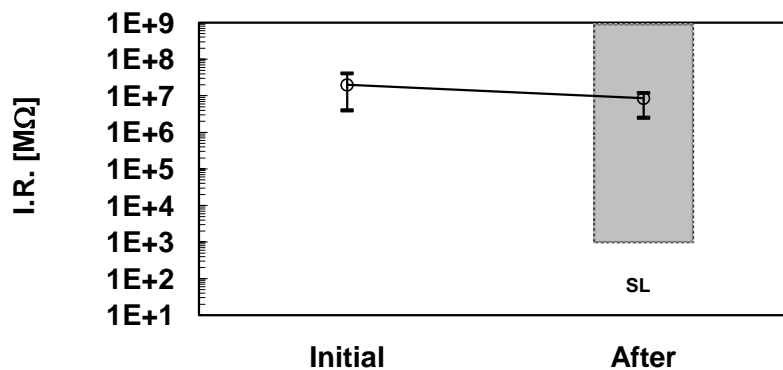

Spec.
 1000 MΩ min.