

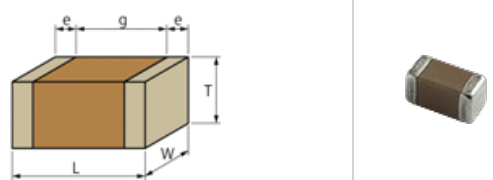

< List of part numbers with package codes >
 GRM1885C1H470JA01D , GRM1885C1H470JA01J

Shape



L size	1.6 ±0.1mm
W size	0.8 ±0.1mm
T size	0.8 ±0.1mm
External terminal width e	0.2 to 0.5mm
Distance between external terminals g	0.5mm min.
Size code in inch(mm)	0603 (1608M)

References

Packaging	Specifications	Minimum quantity
D	φ180mm Paper taping	4000
J	φ330mm Paper taping	10000

Mass (typ.)	
1 piece	6.3mg
φ180mm Reel	144g

Specifications

Capacitance	47pF ±5%
Rated voltage	50Vdc
Temperature characteristics (complied standard)	C0G(EIA)
Temperature coefficient	0±30ppm/°C
Temperature range of temperature characteristics	25 to 125°C
Operating temperature range	-55 to 125°C

Attention

- 1.This datasheet is downloaded from the website of Murata Manufacturing Co., Ltd. Therefore, it's specifications are subject to change or our products in it may be discontinued without advance notice. Please check with our sales representatives or product engineers before ordering.
- 2.This datasheet has only typical specifications because there is no space for detailed specifications. Therefore, please review our product specifications or consult the approval sheet for product specifications before ordering.