

LOC	DIST	REVISIONS					
E	B	P	LTR	DESCRIPTION	DATE	DWN	APVD
			BA	NEW RELEASE	03-NOV-08	SM	St.P

FOR FURTHER INFORMATION SEE DATA SHEET FOR  
CRG SERIES-THICK FILM CHIP RESISTORS

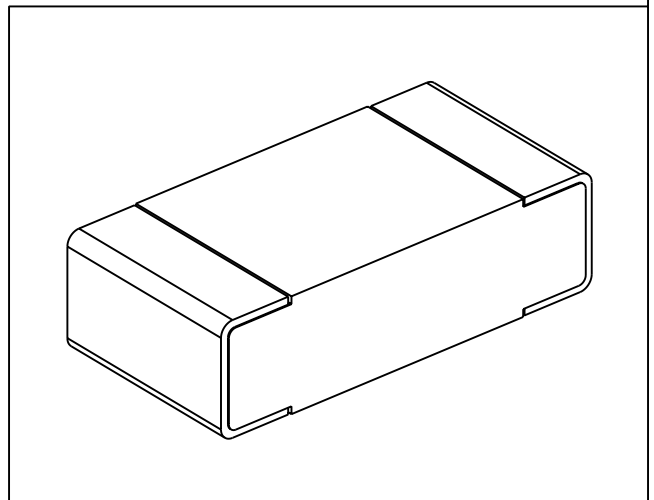
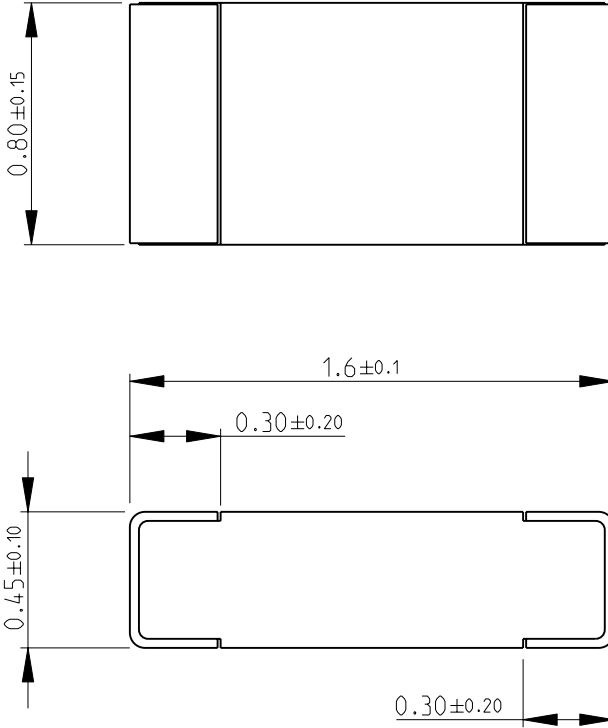

RoHS Compliant

2008

RELEASED FOR PUBLICATION

THIS DRAWING IS UNPUBLISHED.

© COPYRIGHT 2008 BY TYCO ELECTRONICS CORPORATION. ALL RIGHTS RESERVED.

DIMENSIONS: mm	DWN	03-NOV-08	MATERIAL	-	FINISH	-
	CHK	03-NOV-08	Tyco Electronics Corporation Dorcan, Swindon, SN3 5HH			
TOLERANCES UNLESS OTHERWISE SPECIFIED:	APVD	03-NOV-08				
0 PLC $\pm 0.5$	STEPHEN.P		NAME THICK FILM CHIP RESISTORS SERIES CRG 0603			
1 PLC $\pm 0.2$	PRODUCT SPEC	-				
2 PLC $\pm 0.1$	APPLICATION SPEC	-	SIZE	CAGE CODE	DRAWING NO	RESTRICTED TO
3 PLC $\pm -$			A 4	00779	© = 1622861	-
4 PLC $\pm -$	WEIGHT	-	CUSTOMER DRAWING			
ANGLES $\pm 5^\circ$			SCALE	40:1	SHEET	1 OF 1
			REV BA			