

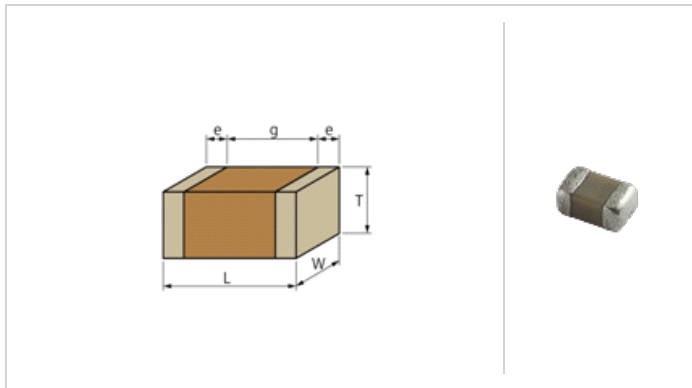

< List of part numbers with package codes >
GCJ55DR72E474KXJ1L , GCJ55DR72E474KXJ1K

Shape



L size	5.7 ±0.4mm
W size	5.0 ±0.4mm
T size	2.0 +0.0/-0.3mm
External terminal width e	0.3mm min.
Distance between external terminals g	3.0mm min.
Size code in inch(mm)	2220 (5750M)

Notes

Resin external electrode products

References

Packaging	Specifications	Minimum quantity
L	φ180mm Embossed taping	1000
K	φ330mm Embossed taping	4000

Mass (typ.)	
1 piece	290mg
φ180mm Reel	347g

Specifications

Capacitance	0.47μF ±10%
Rated voltage	250Vdc
Temperature characteristics (complied standard)	X7R(EIA)
Capacitance change rate	±15.0%
Temperature range of temperature characteristics	-55 to 125°C
Operating temperature range	-55 to 125°C

Attention

- 1.This datasheet is downloaded from the website of Murata Manufacturing Co., Ltd. Therefore, it's specifications are subject to change or our products in it may be discontinued without advance notice. Please check with our sales representatives or product engineers before ordering.
- 2.This datasheet has only typical specifications because there is no space for detailed specifications. Therefore, please review our product specifications or consult the approval sheet for product specifications before ordering.