

40V General Purpose Precision Operational Amplifier

ISL28177

The ISL28177 is an OP07 replacement featuring low input offset voltage, low input bias current, and competitive noise and AC performance. The ESD ratings are best among competitive parts at 5kV HBM, 300V MM, and 2.2kV CDM. The amplifier operates over the 6V ($\pm 3V$) to 40V ($\pm 20V$) range.

Applications include precision active filters, medical and analytical instrumentation, precision power supply controls, and industrial sensors.

The ISL28177 is available in the SOT23-5 and SOIC-8 packages and operates over the extended temperature range to -40°C to $+125^{\circ}\text{C}$.

Features

- Wide Supply Range 6V ($\pm 3V$) to 40V ($\pm 20V$)
- Low Input Offset Voltage 150 μV , Max
- Input Bias Current 1nA, Max
- Low Noise 9.5nV/ $\sqrt{\text{Hz}}$ @ 1kHz
- Gain Bandwidth 600kHz
- Exceptional ESD Performance 5kV HBM, 300V MM, 2.2kV CDM
- Operating Temperature Range -40°C to $+125^{\circ}\text{C}$
- Packages
 - ISL28177 (Single) SOT23-5, SOIC-8

Applications

- Precision Active Filters
- Medical and Analytical Instrumentation
- Precision Power Supply Controls
- Industrial Sensors

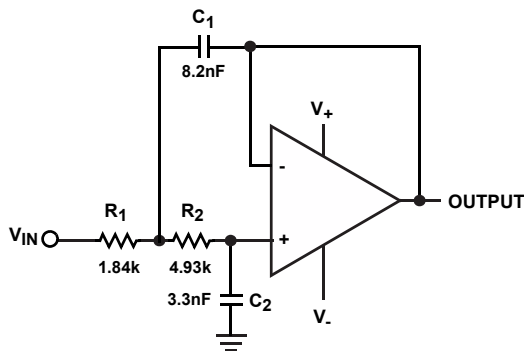

SALLEN-KEY LOW PASS FILTER (10kHz)

FIGURE 1. TYPICAL APPLICATION

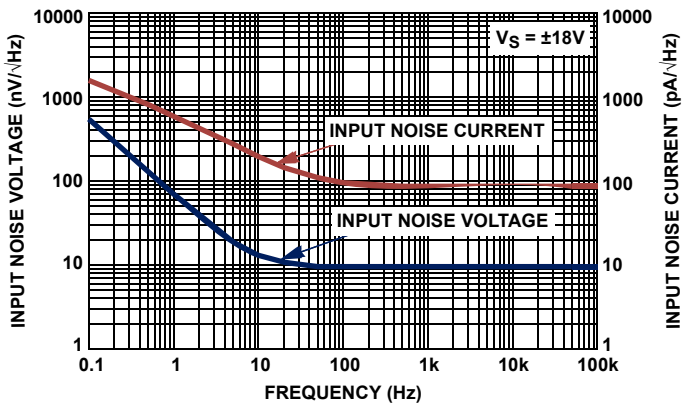

FIGURE 2. INPUT NOISE PERFORMANCE

ISL28177

Ordering Information

PART NUMBER (Note 2, 3)	PART MARKING	TEMP RANGE (°C)	PACKAGE (Pb-free)	PKG. DWG. #
ISL28177FBZ	28177 FBZ	-40 to +125	8 Ld SOIC	M8.15E
ISL28177FBZ-T13 (Note 1)	28177 FBZ	-40 to +125	8 Ld SOIC	M8.15E
ISL28177FBZ-T7 (Note 1)	28177 FBZ	-40 to +125	8 Ld SOIC	M8.15E
ISL28177FBZ-T7A (Note 1)	28177 FBZ	-40 to +125	8 Ld SOIC	M8.15E
Coming Soon ISL28177FHZ	TBD	-40 to +125	SOT23-5	P5.064A

NOTES:

1. Please refer to [TB347](#) for details on reel specifications.
2. These Intersil Pb-free plastic packaged products employ special Pb-free material sets, molding compounds/die attach materials, and 100% matte tin plate plus anneal (e3 termination finish, which is RoHS compliant and compatible with both SnPb and Pb-free soldering operations). Intersil Pb-free products are MSL classified at Pb-free peak reflow temperatures that meet or exceed the Pb-free requirements of IPC/JEDEC J STD-020.
3. For Moisture Sensitivity Level (MSL), please see device information page for [ISL28177](#). For more information on MSL please see techbrief [TB363](#).

Pin Configurations

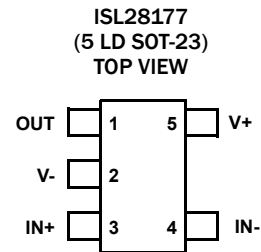
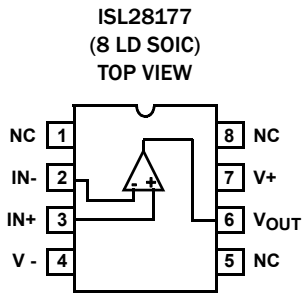

Pin Descriptions

ISL28177 (8 LD SOIC)	ISL28177 (5 LD SOT-23)	PIN NAME	EQUIVALENT CIRCUIT	DESCRIPTION
3	3	IN+	Circuit 1	Amplifier non-inverting input
4	2	V-	Circuit 3	Negative power supply
2	4	IN-	Circuit 1	Amplifier inverting input
7	5	V+	Circuit 3	Positive power supply
6	1	V _{OUT}	Circuit 2	Amplifier output
1, 5, 8	-	NC	-	No internal connection

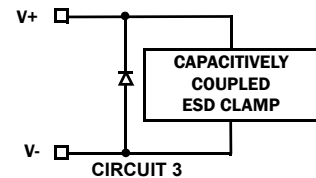
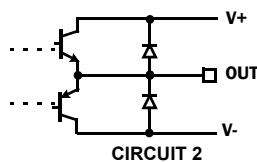
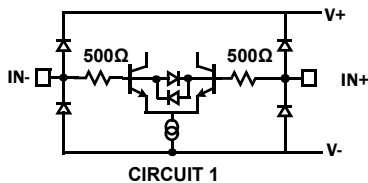

ISL28177

Absolute Maximum Ratings

Maximum Supply Voltage	44V
Maximum Differential Input Voltage	44V or $V_- - 0.5V$ to $V_+ + 0.5V$
Min/Max Input Voltage	44V or $V_- - 0.5V$ to $V_+ + 0.5V$
Min/Max Input Current	20mA
Output Short-Circuit Duration (1 output at a time)	Indefinite
ESD Ratings	
Human Body Model (Tested per JESD22-A114F)	5kV
Machine Model (Tested per JESD22-A115-A)	300V
Charged Device Model (Tested per CDM-22C10ID)	2.2kV

Thermal Information

Thermal Resistance (Typical)	θ_{JA} (°C/W)	θ_{JC} (°C/W)
5 Ld SOT-23 Package (Notes 4, 5)	TBD	TBD
8 Ld SOIC Package (Notes 4, 5)	125	73
Storage Temperature Range	-65°C to +150°C	
Pb-free Reflow Profile	see link below http://www.intersil.com/pbfree/Pb-FreeReflow.asp	

Operating Conditions

Ambient Operating Temperature Range	-40°C to +125°C
Maximum Operating Junction Temperature	+150°C
Operating Voltage Range	.6V ($\pm 3V$) to 40V ($\pm 20V$)

CAUTION: Do not operate at or near the maximum ratings listed for extended periods of time. Exposure to such conditions may adversely impact product reliability and result in failures not covered by warranty.

NOTES:

- θ_{JA} is measured with the component mounted on a high effective thermal conductivity test board in free air. See Tech Brief [TB379](#) for details.
- For θ_{JC} , the "case temp" location is taken at the package top center.

Electrical Specifications $V_S = \pm 5V$ to $\pm 15V$, $R_L = \text{Open}$, $V_{CM} = 0V$, $T_A = +25^\circ\text{C}$, unless otherwise specified. **Boldface limits apply over the operating temperature range, -40°C to +125°C.**

PARAMETER	DESCRIPTION	CONDITIONS	MIN (Note 6)	TYP	MAX (Note 6)	UNIT
V_{OS}	Input Offset Voltage				150	μV
		-40°C to +85°C			250	μV
		-40°C to +125°C			350	μV
TCV_{OS}	Input Offset Voltage Temperature Coefficient	-40°C to +125°C		0.5	1.4	$\mu\text{V}/^\circ\text{C}$
$\Delta V_{OS}/\text{Time}$	Long Term V_{OS} Stability			0.4		$\mu\text{V}/\text{mo}$
I_B	Input Bias Current			0.2	1	nA
		-40°C to +125°C			1	nA
I_{OS}	Input Offset Current			0.2	1	nA
		-40°C to +125°C			1	nA
e_N	Input Noise Voltage	$f = 0.1\text{Hz}$ to 10Hz		0.38		μV_{P-P}
	Input Noise Voltage Density	$f = 10\text{Hz}$		13		$\text{nV}/\sqrt{\text{Hz}}$
	Input Noise Voltage Density	$f = 100\text{Hz}$		9.6		$\text{nV}/\sqrt{\text{Hz}}$
	Input Noise Voltage Density	$f = 1\text{kHz}$		9.5		$\text{nV}/\sqrt{\text{Hz}}$
i_N	Input Noise Current Density	$f = 1\text{kHz}$		87		$\text{fA}/\sqrt{\text{Hz}}$
V_{CMIR}	Common Mode Input Voltage Range	Guaranteed by CMRR test	$V_- + 2$		$V_+ - 2$	V
CMRR	Common Mode Rejection Ratio	$V_{CM} = V_- + 2V$ to $V_+ - 2V$	120	140		dB
			120			dB
PSRR	Power Supply Rejection Ratio	$V_S = \pm 3V$ to $\pm 20V$	115	130		dB
			115			dB
V_{OL}	Output Voltage Low, V_{OUT} to V_-	$R_L = 2\text{k}\Omega$		1.2	1.25	V
		$R_L = 2\text{k}\Omega$, -40°C to +125°C			1.3	V
V_{OH}	Output Voltage High, V_+ to V_{OUT}	$R_L = 2\text{k}\Omega$		1.2	1.25	V
		$R_L = 2\text{k}\Omega$, -40°C to +125°C			1.3	V
SR	Slew Rate	$R_L = 2\text{k}\Omega$, $C_L = 100\text{pF}$		0.2		$\text{V}/\mu\text{s}$
GBWP	Gain Bandwidth Product	$R_L = 100\text{k}\Omega$, $C_L = 60\text{pF}$		600		kHz
AVOL	Large Signal Gain	$V_{OUT} = \pm 3V$ to $\pm 13V$, $R_L = 10\text{k}\Omega$	120	140		dB
			120			dB

ISL28177

Electrical Specifications $V_S = \pm 5V$ to $\pm 15V$, $R_L = \text{Open}$, $V_{CM} = 0V$, $T_A = +25^\circ\text{C}$, unless otherwise specified. **Boldface limits apply over the operating temperature range, -40°C to $+125^\circ\text{C}$.** (Continued)

PARAMETER	DESCRIPTION	CONDITIONS	MIN (Note 6)	TYP	MAX (Note 6)	UNIT
I_S	Supply Current			1.18	1.4	mA
					1.7	mA
V_S	Supply Voltage		$\pm 3V$		$\pm 20V$	V
I_{SC}	Short Circuit Current			30		mA

NOTE:

6. Compliance to datasheet limits is assured by one or more methods: production test, characterization and/or design.

Typical Performance Curves $V_S = \pm 15V$, $V_{CM} = 0V$, $R_L = \text{Open}$, unless otherwise specified.

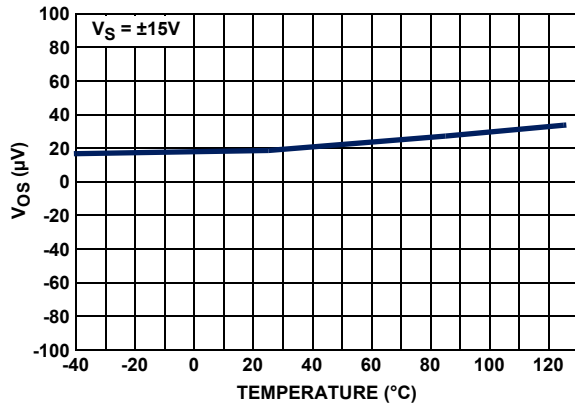

FIGURE 3. INPUT OFFSET VOLTAGE (V_{OS}) vs TEMPERATURE

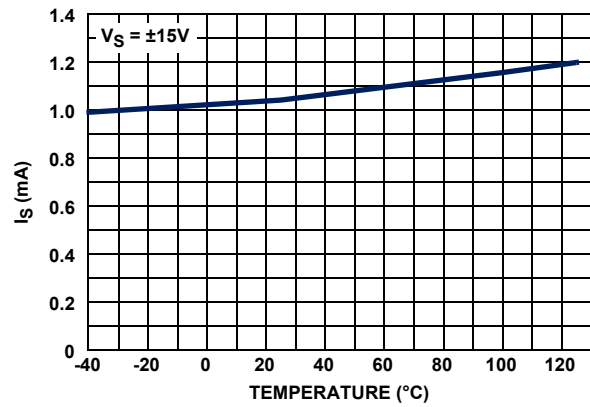

FIGURE 4. POWER SUPPLY CURRENT (I_S) vs TEMPERATURE

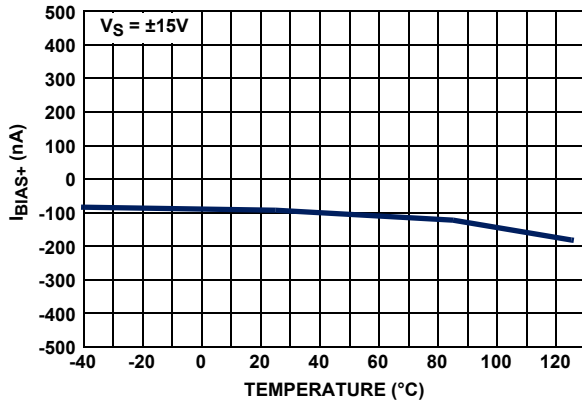

FIGURE 5. POSITIVE INPUT BIAS CURRENT (I_{IB+}) vs TEMPERATURE

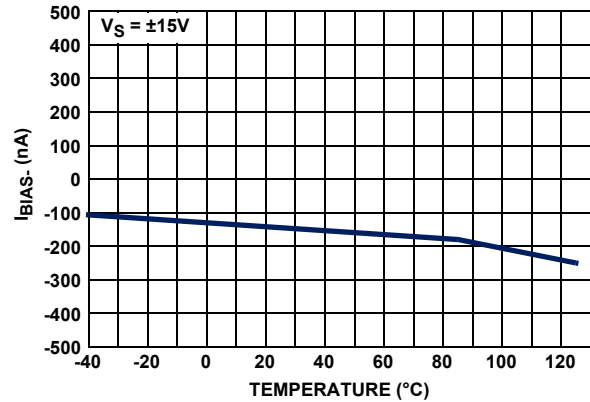

FIGURE 6. NEGATIVE INPUT BIAS CURRENT (I_{IB-}) vs TEMPERATURE

Typical Performance Curves $V_S = \pm 15V, V_{CM} = 0V, R_L = \text{Open}$, unless otherwise specified. (Continued)

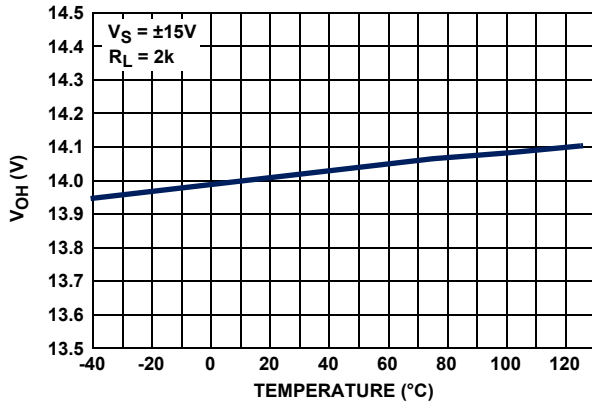

FIGURE 7. POSITIVE OUTPUT VOLTAGE (V_{OH}) vs TEMPERATURE

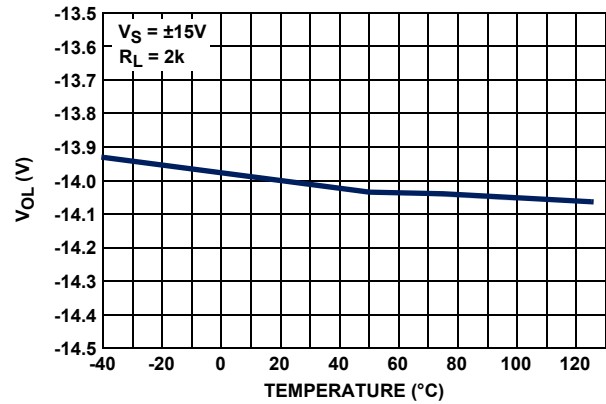

FIGURE 8. POSITIVE OUTPUT VOLTAGE (V_{OL}) vs TEMPERATURE

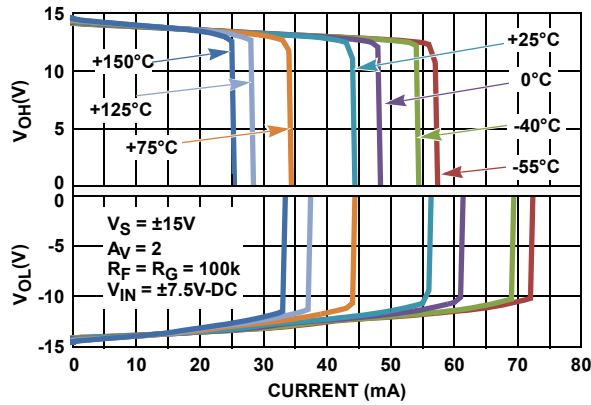

FIGURE 9. POSITIVE OUTPUT VOLTAGE (V_{OUT}) vs OUTPUT CURRENT (I_{OUT}) vs TEMPERATURE

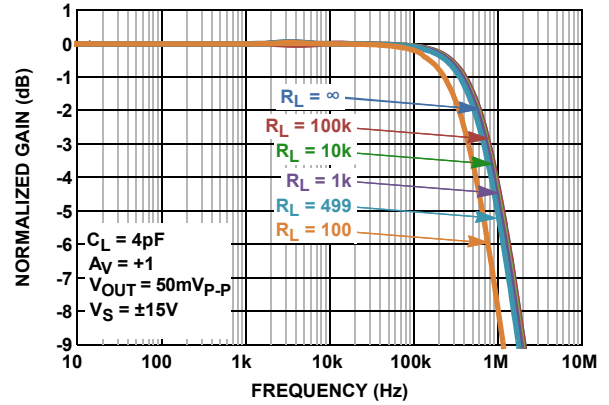

FIGURE 10. UNITY GAIN FREQUENCY RESPONSE vs R_L

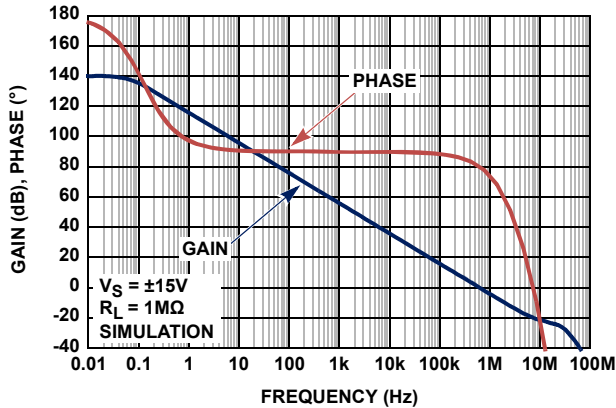

FIGURE 11. OPEN LOOP GAIN-PHASE vs FREQUENCY

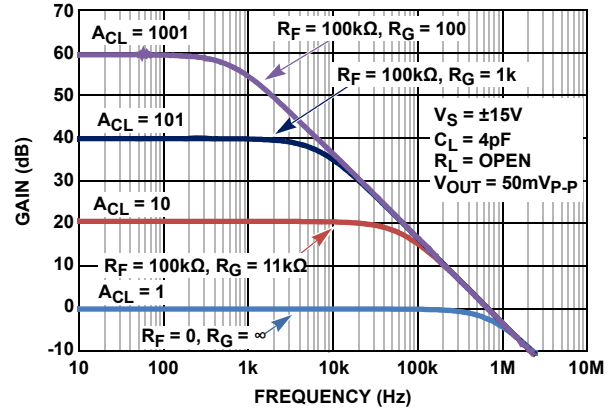

FIGURE 12. FREQUENCY RESPONSE vs CLOSED LOOP GAIN

Typical Performance Curves $V_S = \pm 15V$, $V_{CM} = 0V$, $R_L = \text{Open}$, unless otherwise specified. (Continued)

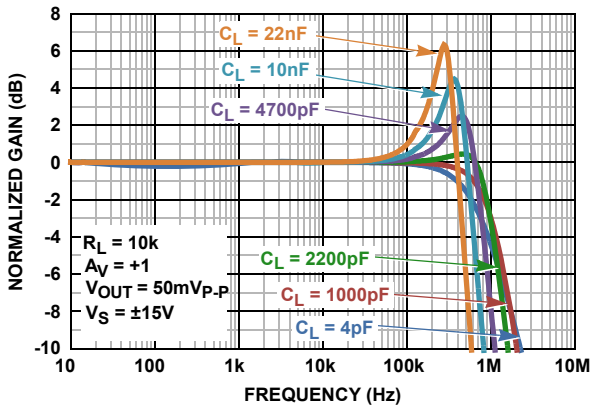

FIGURE 13. UNITY GAIN FREQUENCY RESPONSE vs C_L

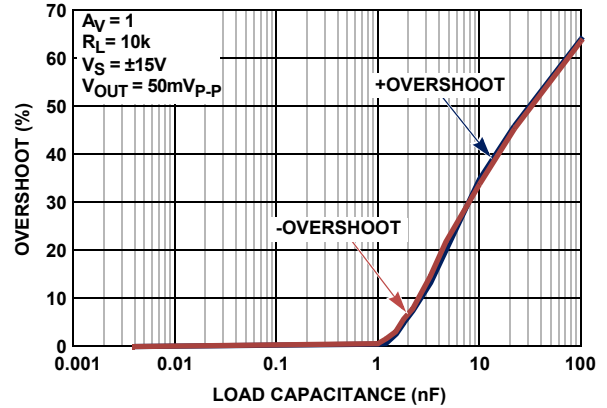

FIGURE 14. OVERSHOOT vs LOAD CAPACITANCE

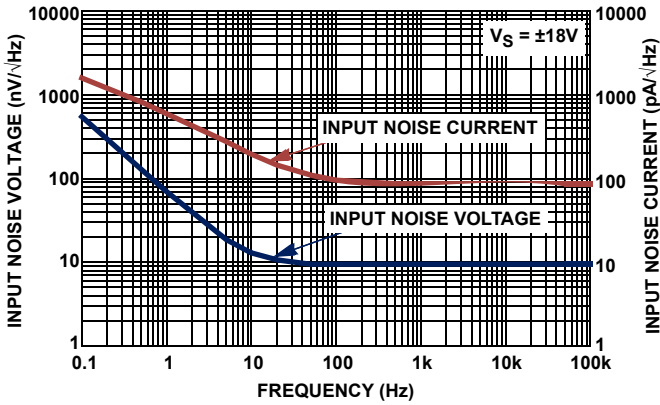

FIGURE 15. INPUT NOISE VOLTAGE AND CURRENT SPECTRAL DENSITY

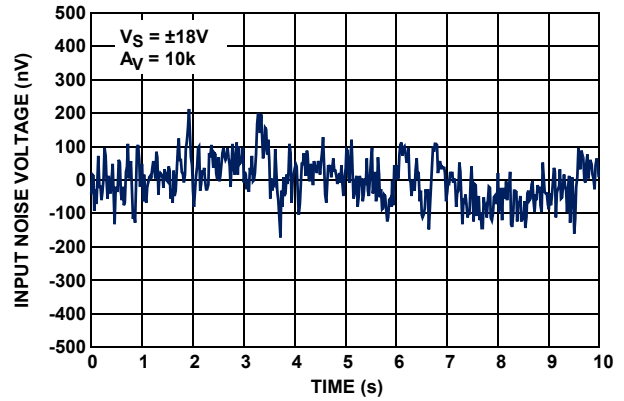

FIGURE 16. INPUT NOISE VOLTAGE 0.1Hz to 10Hz

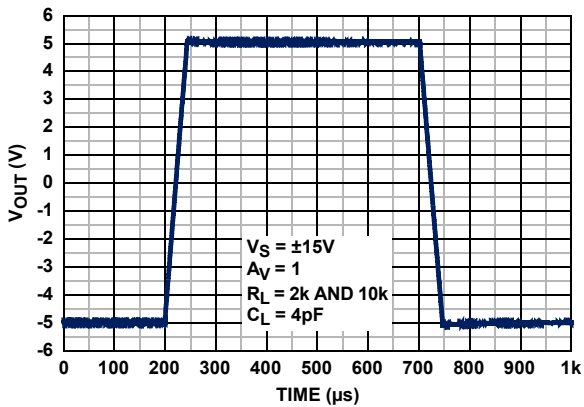

FIGURE 17. LARGE SIGNAL TRANSIENT RESPONSE

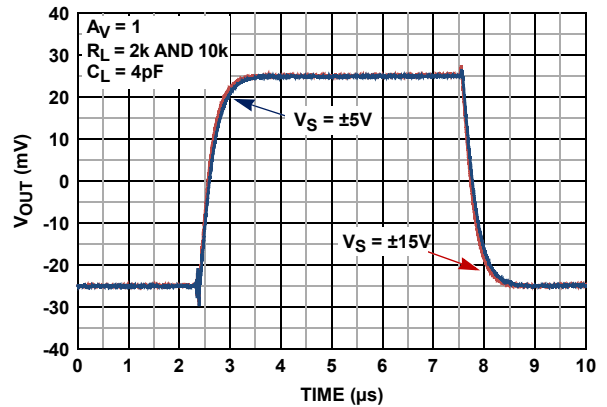

FIGURE 18. SMALL SIGNAL TRANSIENT RESPONSE

Typical Performance Curves $V_S = \pm 15V, V_{CM} = 0V, R_L = \text{Open}$, unless otherwise specified. (Continued)

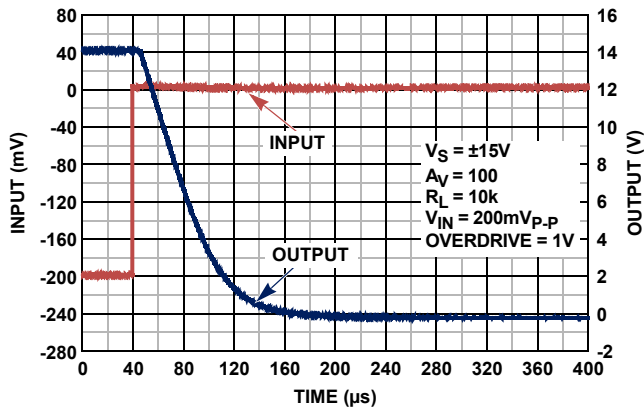

FIGURE 19. POSITIVE OUTPUT OVERLOAD RESPONSE TIME

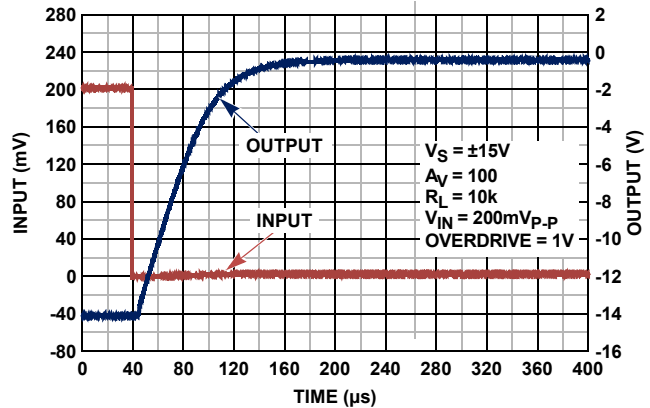

FIGURE 20. NEGATIVE OUTPUT OVERLOAD RESPONSE TIME

Applications Information

Functional Description

The ISL28177 is a low noise op amp fabricated in a 40V complementary bipolar DI process designed for general purpose low power applications. It utilizes a super-beta NPN input stage with input bias current cancellation for low input bias current and low input noise voltage. A complimentary bipolar output stage enables high capacitive load drive without external compensation.

Operating Voltage Range

The ISL28177 is designed to operate over the 6V ($\pm 3V$) to 40V ($\pm 20V$) range. The common mode input voltage range extends to 2V from each rail, and the output voltage swings to 1.3V of each rail.

Input Performance

The super-beta NPN input pair reduces input bias current while maintaining good frequency response, low input bias current and low noise. Input bias cancellation circuits provide additional bias current reduction to $<1nA$, and excellent temperature stabilization and low TCV_{OS} .

Input ESD Diode Protection

The input terminals (IN+ and IN-) have internal ESD protection diodes to the positive and negative supply rails, series connected 500 Ω current limiting resistors and an anti-parallel diode pair across the inputs (Figure 21).

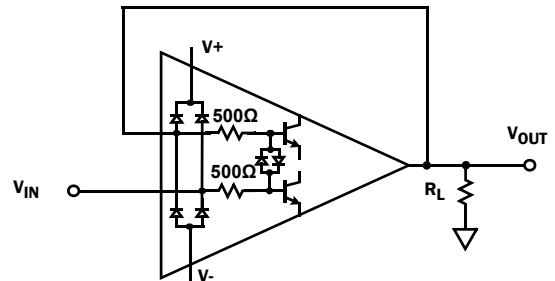

FIGURE 21. INPUT ESD DIODE CURRENT LIMITING

The series resistors limit the high feed-through currents that can occur in pulse applications when the input dv/dt exceeds the 0.2V/ μs slew rate of the amplifier. Without the series resistors, the input can forward-bias the anti-parallel diodes causing current to flow to the output, resulting in severe distortion and possible diode failure. Figure 17 provides an example of distortion free large signal response using a 10V $_{p,p}$ input pulse with an input rise time of $<1ns$. The series resistors enable the input differential voltage to be equal to the maximum power supply voltage (40V) without damage.

In applications where one or both amplifier input terminals are at risk of exposure to high voltages beyond the power supply rails, current limiting resistors may be needed at the input terminal to limit the current through the power supply ESD diodes to 20mA max.

Output Current Limiting

The output current is internally limited to approximately $\pm 30mA$ at $+25^\circ C$ and can withstand a short circuit to either rail as long as the power dissipation limits are not exceeded. Continuous operation under these conditions may degrade long term reliability.

Output Phase Reversal

Output phase reversal is a change of polarity in the amplifier transfer function when the input voltage exceeds the supply voltage. The ISL28177 is immune to output phase reversal.

Power Dissipation

It is possible to exceed the +150°C maximum junction temperature under certain load and power supply conditions. It is therefore important to calculate the maximum junction temperature (T_{JMAX}) for all applications to determine if power supply voltages, load conditions, or package type need to be modified to remain in the safe operating area. These parameters are related using Equation 1:

$$T_{JMAX} = T_{MAX} + \theta_{JA} \times PD_{MAXTOTAL} \quad (EQ. 1)$$

where:

- $PD_{MAXTOTAL}$ is the sum of the maximum power dissipation of each amplifier in the package (PD_{MAX})
- PD_{MAX} for each amplifier can be calculated using Equation 2:

$$PD_{MAX} = V_S \times I_{qMAX} + (V_S - V_{OUTMAX}) \times \frac{V_{OUTMAX}}{R_L} \quad (EQ. 2)$$

where:

- T_{MAX} = Maximum ambient temperature
- θ_{JA} = Thermal resistance of the package
- PD_{MAX} = Maximum power dissipation of 1 amplifier
- V_S = Total supply voltage
- I_{qMAX} = Maximum quiescent supply current of 1 amplifier
- V_{OUTMAX} = Maximum output voltage swing of the application

ISL28177 SPICE Model

Figure 22 shows the SPICE model schematic and Figure 23 shows the net list for the SPICE model. The model is a simplified version of the actual device and simulates important AC and DC parameters. AC parameters incorporated into the model are: 1/f and flatband noise voltage, Slew Rate, CMRR, Gain and Phase. The DC parameters are, V_{OS} , I_{OS} , total supply current and output voltage swing. The model uses typical parameters given in the “Electrical Specifications” table beginning on page 3. The AVOL is adjusted for 140dB with the dominant pole at 0.075Hz. The CMRR is set 145dB, $f_{cm} = 500kHz$. The input stage models the actual device to present an accurate AC representation. The model is configured for ambient temperature of +25°C.

Figures 24 through 37 show the characterization vs simulation results for the Noise Voltage, Closed Loop Gain vs Frequency, Small Signal 0.1V Step, Large Signal 5V Step Response, Open Loop Gain Phase, CMRR, Unity Gain Frequency Response vs C_L and Output Voltage Swing for $\pm 15V$ supplies.

LICENSE STATEMENT

The information in this SPICE model is protected under the United States copyright laws. Intersil Corporation hereby grants users of this macro-model hereto referred to as “Licensee”, a nonexclusive, nontransferable license to use this model as long as the Licensee abides by the terms of this agreement. Before using this macro-model, the Licensee should read this license. If the Licensee does not accept these terms, permission to use the model is not granted.

The Licensee may not sell, loan, rent, or license the macro-model, in whole, in part, or in modified form, to anyone outside the Licensee’s company. The Licensee may modify the macro-model to suit his/her specific applications, and the Licensee may make copies of this macro-model for use within their company only.

This macro-model is provided “AS IS, WHERE IS, AND WITH NO WARRANTY OF ANY KIND EITHER EXPRESSED OR IMPLIED, INCLUDING BUT NOT LIMITED TO ANY IMPLIED WARRANTIES OF MERCHANTABILITY AND FITNESS FOR A PARTICULAR PURPOSE.”

In no event will Intersil be liable for special, collateral, incidental, or consequential damages in connection with or arising out of the use of this macro-model. Intersil reserves the right to make changes to the product and the macro-model without prior notice.

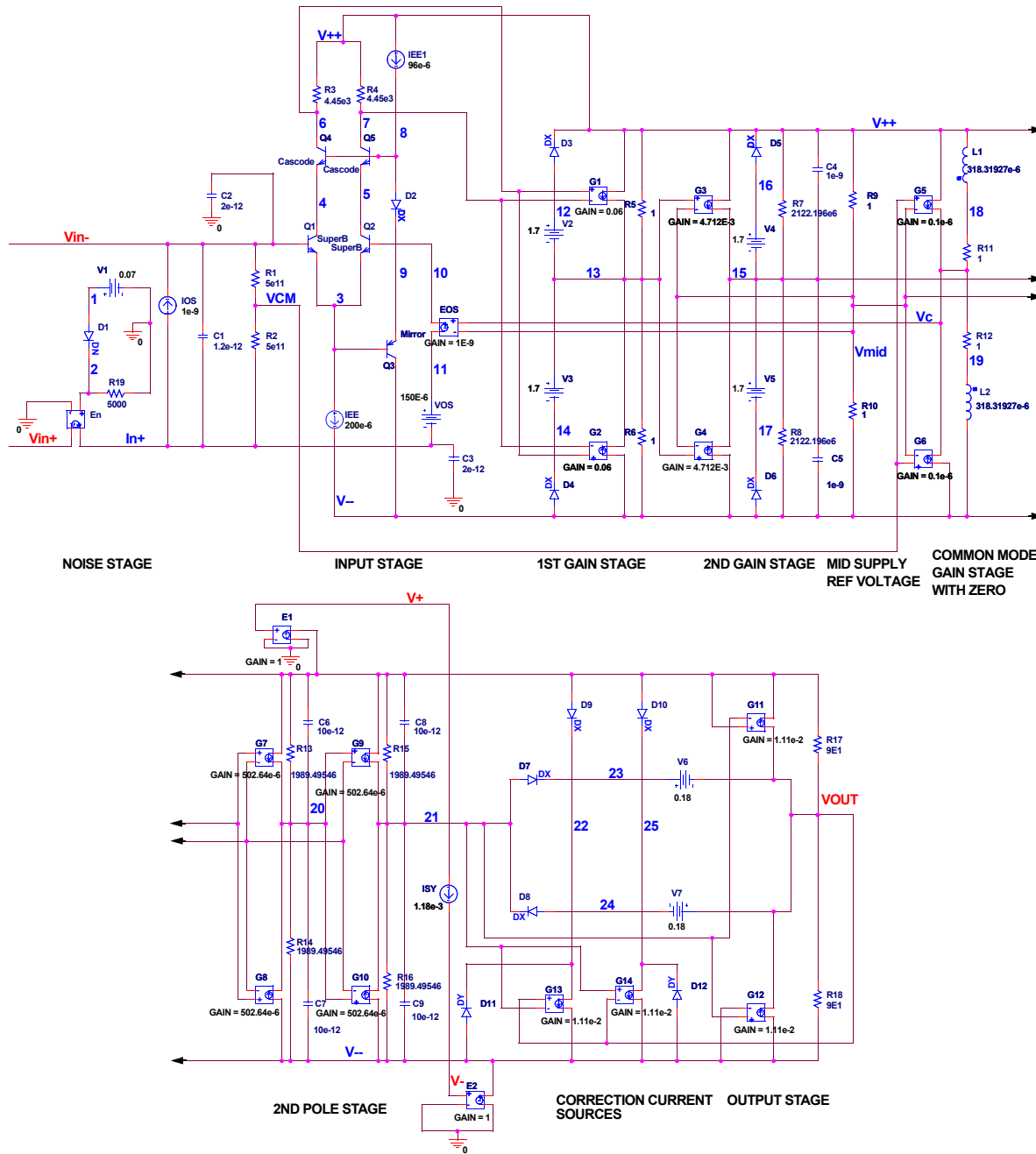

FIGURE 22. SPICE MODEL SCHEMATIC

Characterization vs Simulation Results

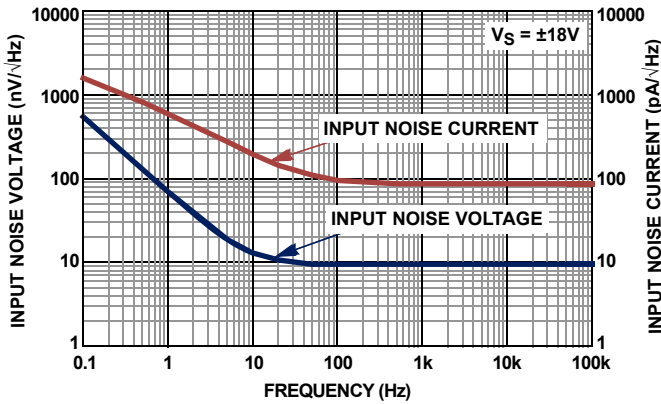

FIGURE 24. CHARACTERIZED INPUT NOISE VOLTAGE

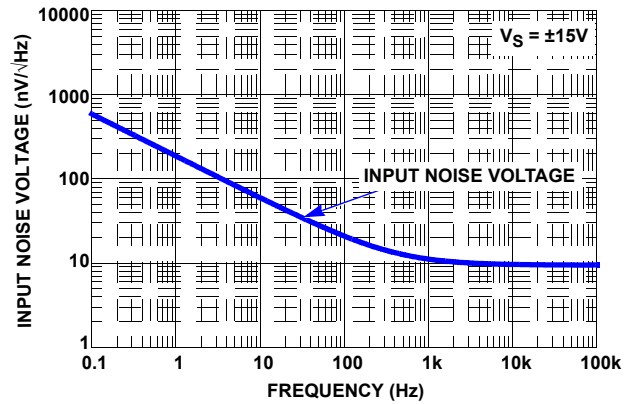

FIGURE 25. SIMULATED INPUT NOISE VOLTAGE

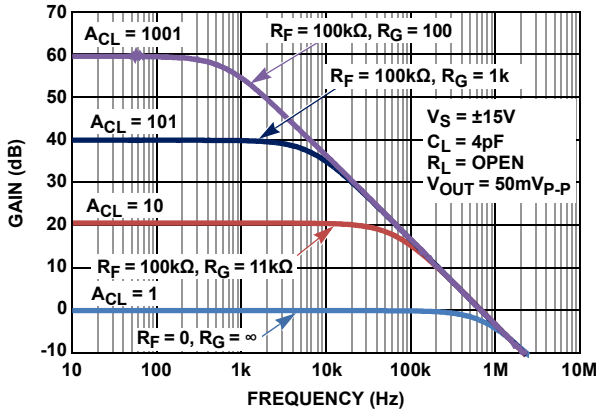

FIGURE 26. CHARACTERIZED CLOSED LOOP GAIN vs FREQUENCY

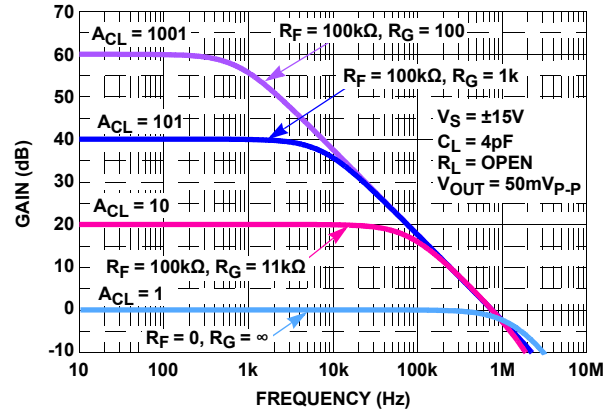

FIGURE 27. SIMULATED CLOSED LOOP GAIN vs FREQUENCY

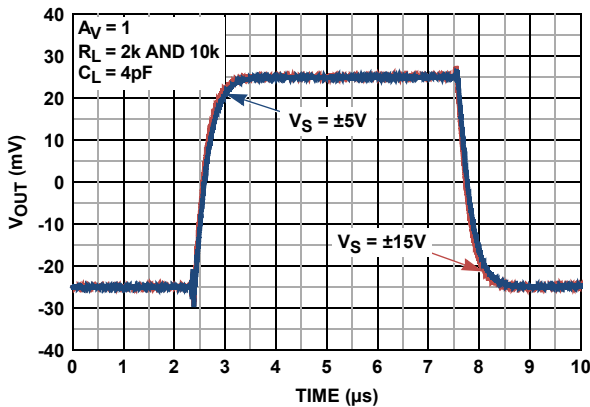

FIGURE 28. CHARACTERIZED SMALL SIGNAL TRANSIENT RESPONSE vs R_L , $V_S = \pm 0.9V, \pm 2.5V$

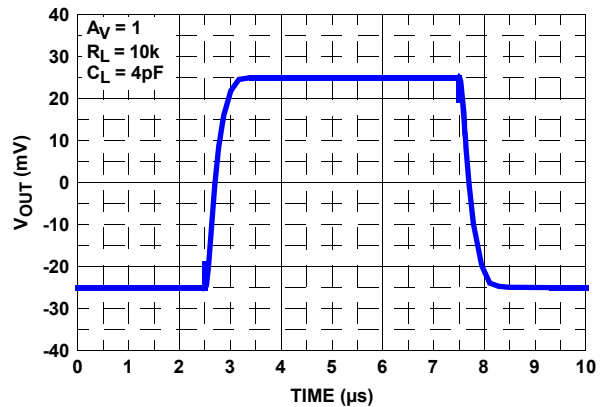

FIGURE 29. SIMULATED SMALL SIGNAL TRANSIENT RESPONSE $V_S = \pm 15V$

Characterization vs Simulation Results (Continued)

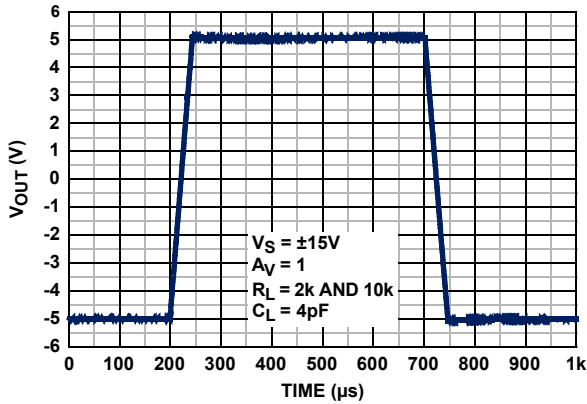

FIGURE 30. CHARACTERIZED LARGE SIGNAL TRANSIENT RESPONSE vs R_L , $V_S = \pm 15V$

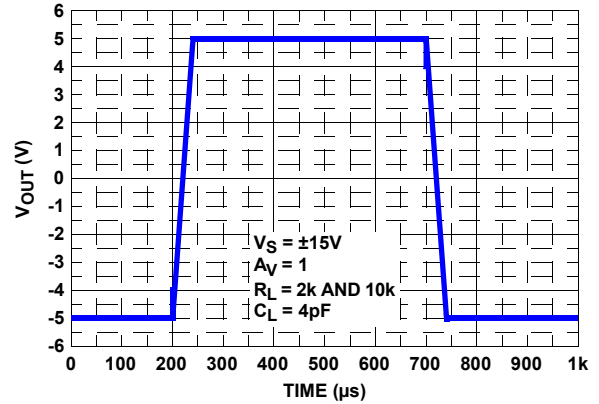

FIGURE 31. SIMULATED LARGE SIGNAL TRANSIENT RESPONSE, $V_S = \pm 14V$

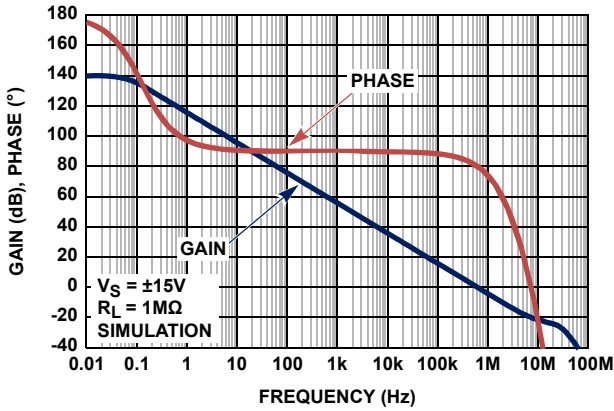

FIGURE 32. SIMULATED (DESIGN) OPEN-LOOP GAIN, PHASE vs FREQUENCY

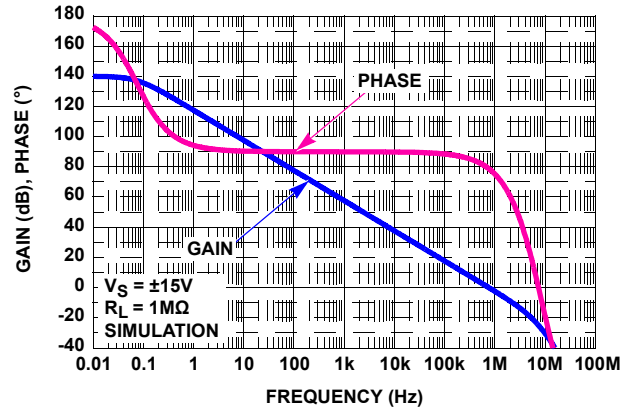

FIGURE 33. SIMULATED (SPICE) OPEN-LOOP GAIN, PHASE vs FREQUENCY

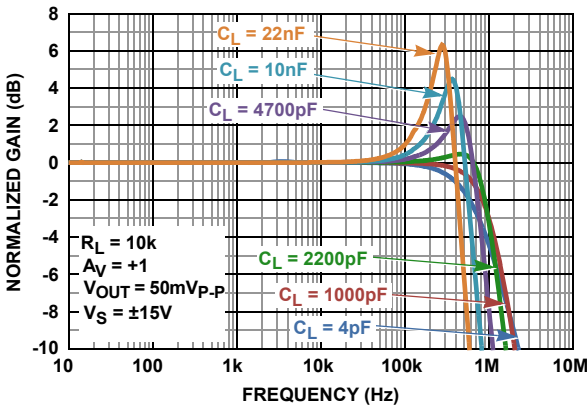

FIGURE 34. CHARACTERIZED UNITY GAIN FREQUENCY RESPONSE vs C_L

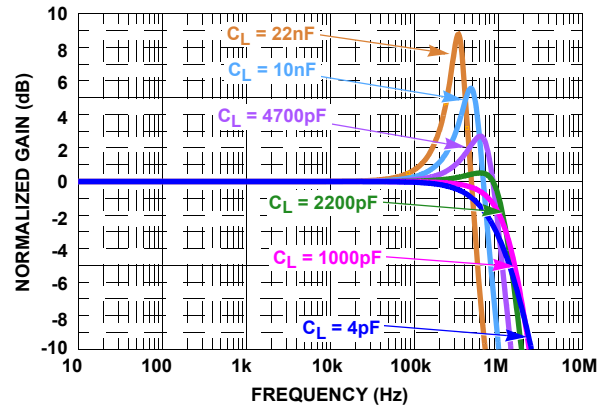

FIGURE 35. SIMULATED UNITY GAIN FREQUENCY RESPONSE vs C_L

Characterization vs Simulation Results (Continued)

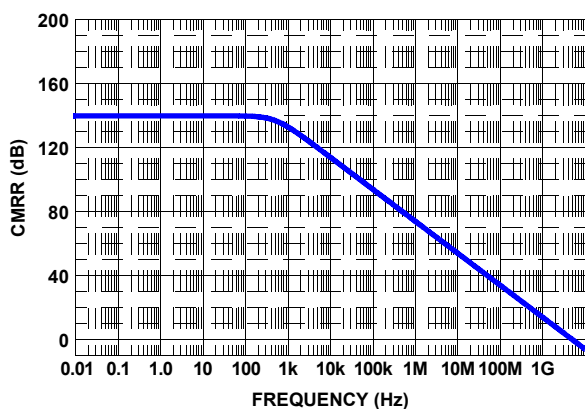

FIGURE 36. SIMULATED (SPICE) CMRR

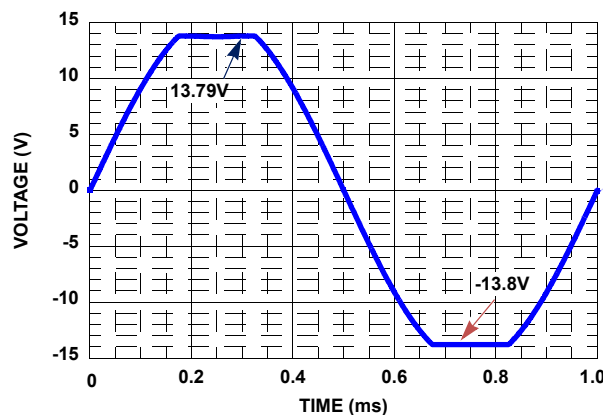

FIGURE 37. SIMULATED OUTPUT VOLTAGE SWING $\pm 15V$

Revision History

The revision history provided is for informational purposes only and is believed to be accurate, but not warranted. Please go to web to make sure you have the latest Rev.

DATE	REVISION	CHANGE
March 29, 2012	FN7859.2	Changed Note 1 in "Ordering Information" on page 2 from: "Add "-T*" suffix for tape and reel. Please refer to TB347 for details on reel specifications." to: "Please refer to TB347 for details on reel specifications." Listed out tape and reel parts individually in "Ordering Information" on page 2 (ISL28177FBZ-T13, ISL28177FBZ-T7, ISL28177FBZ-T7A)
January 5, 2012	FN7859.1	Added SPICE model to data sheet. Added ESD Ratings to description on page 1.
October 31, 2011	FN7859.0	Initial Release

Products

Intersil Corporation is a leader in the design and manufacture of high-performance analog semiconductors. The Company's products address some of the industry's fastest growing markets, such as, flat panel displays, cell phones, handheld products, and notebooks. Intersil's product families address power management and analog signal processing functions. Go to www.intersil.com/products for a complete list of Intersil product families.

For a complete listing of Applications, Related Documentation and Related Parts, please see the respective device information page on intersil.com: [ISL28177](http://intersil.com/ISL28177)

To report errors or suggestions for this datasheet, please go to: www.intersil.com/askourstaff

FITs are available from our website at: <http://rel.intersil.com/reports/sear>

For additional products, see www.intersil.com/product_tree

Intersil products are manufactured, assembled and tested utilizing ISO9000 quality systems as noted in the quality certifications found at www.intersil.com/design/quality

Intersil products are sold by description only. Intersil Corporation reserves the right to make changes in circuit design, software and/or specifications at any time without notice. Accordingly, the reader is cautioned to verify that data sheets are current before placing orders. Information furnished by Intersil is believed to be accurate and reliable. However, no responsibility is assumed by Intersil or its subsidiaries for its use; nor for any infringements of patents or other rights of third parties which may result from its use. No license is granted by implication or otherwise under any patent or patent rights of Intersil or its subsidiaries.

For information regarding Intersil Corporation and its products, see www.intersil.com

Package Outline Drawing (M8.15E)

M8.15E

8 LEAD NARROW BODY SMALL OUTLINE PLASTIC PACKAGE

Rev 0, 08/09

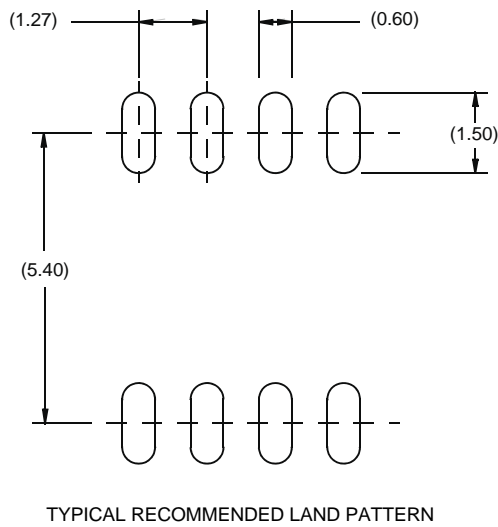
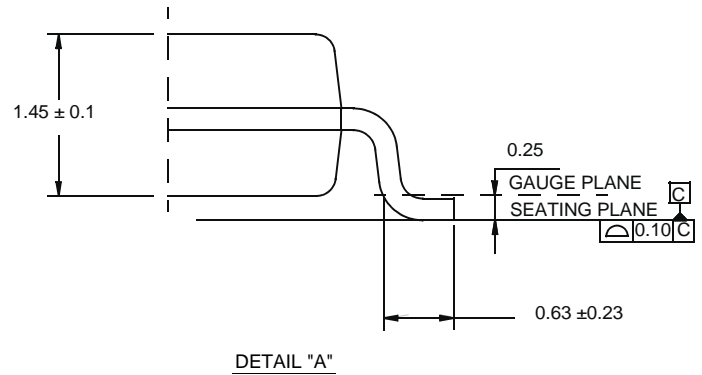
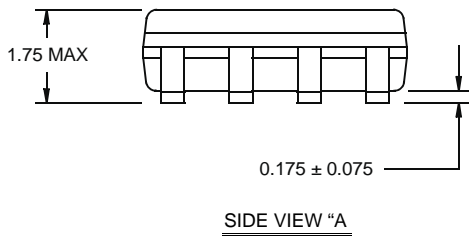
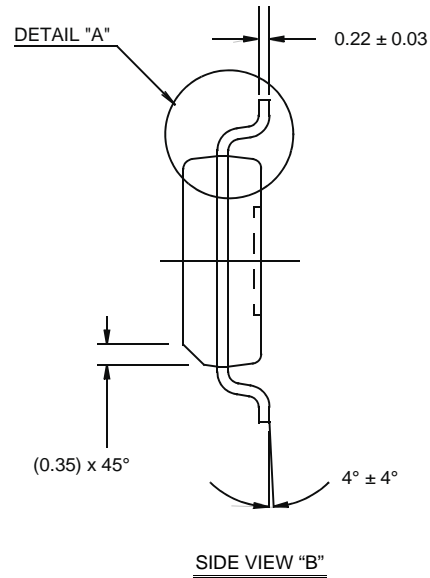
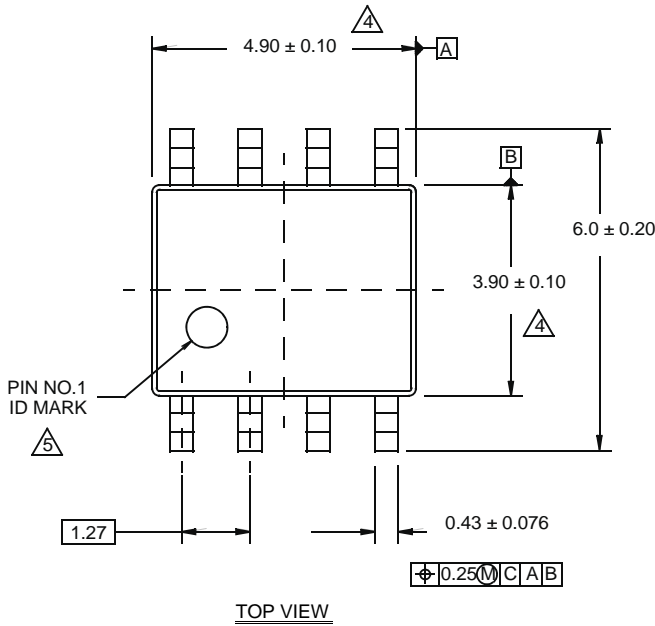

NOTES:

1. Dimensions are in millimeters.
Dimensions in () for Reference Only.
2. Dimensioning and tolerancing conform to AMSE Y14.5m-1994.
3. Unless otherwise specified, tolerance : Decimal ± 0.05
4. Dimension does not include interlead flash or protrusions.
Interlead flash or protrusions shall not exceed 0.25mm per side.
5. The pin #1 identifier may be either a mold or mark feature.
6. Reference to JEDEC MS-012.

Package Outline Drawing

P5.064A

5 LEAD SMALL OUTLINE TRANSISTOR PLASTIC PACKAGE

Rev 0, 2/10

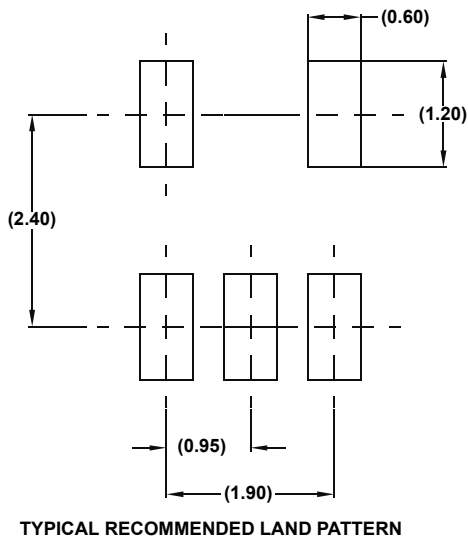
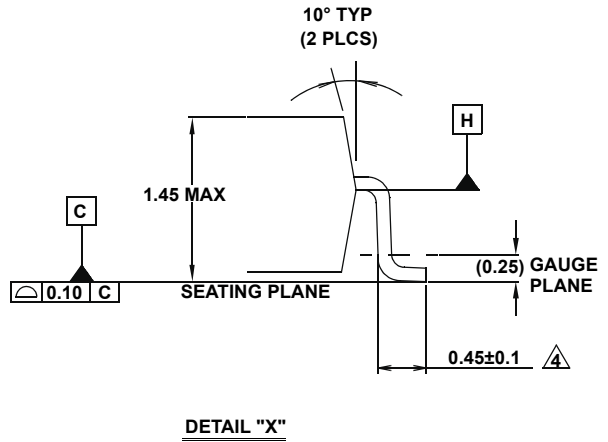
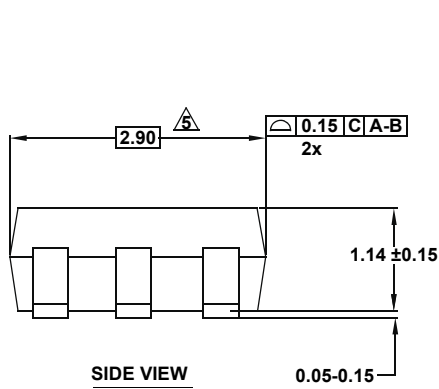
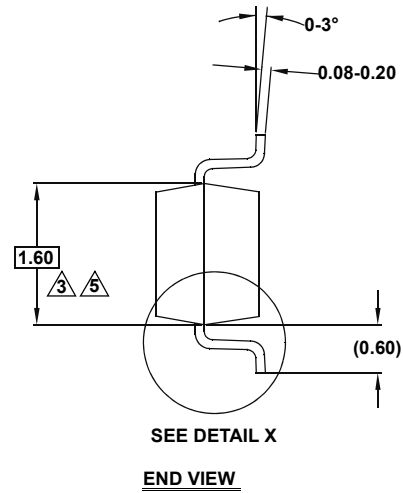
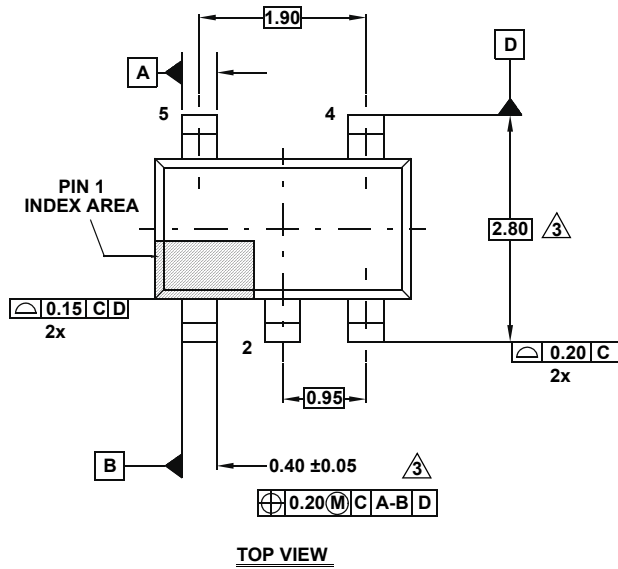

NOTES:

1. Dimensions are in millimeters.
Dimensions in () for Reference Only.
2. Dimensioning and tolerancing conform to ASME Y14.5M-1994.
3. Dimension is exclusive of mold flash, protrusions or gate burrs.
4. Foot length is measured at reference to gauge plane.
5. This dimension is measured at Datum "H".
6. Package conforms to JEDEC MO-178AA.