

CGJ3E2C0G1H040C080AA

TDK Item Description : CGJ3E2C0G1H040CT***



Application & Main Feature

High Reliability Grade (General (Up to 50V))

Series

CGJ3(1608) [EIA CC0603]

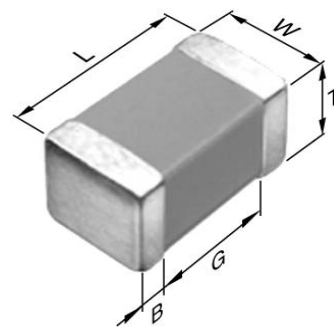

Dimensions

L 1.60mm +/-0.1mm
W 0.80mm +/-0.1mm
T 0.80mm +/-0.1mm
B 0.20mm Min.
G 0.30mm Min.

Temperature Characteristic

C0G (-55 to 125 degC 0+/-30ppm/degC)

Rated Voltage

1H (50Vdc)

Capacitance

4pF

Capacitance Tolerance

C (+/-0.25pF)

Q Factor

480 Min.

Insulation Resistance

10Gohm Min.

AEC-Q200

Yes

|Z|, ESR vs. Freq. Characteristics

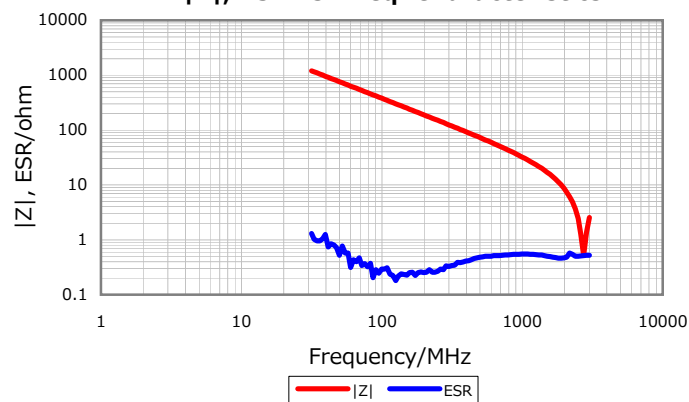

DC Bias Characteristic

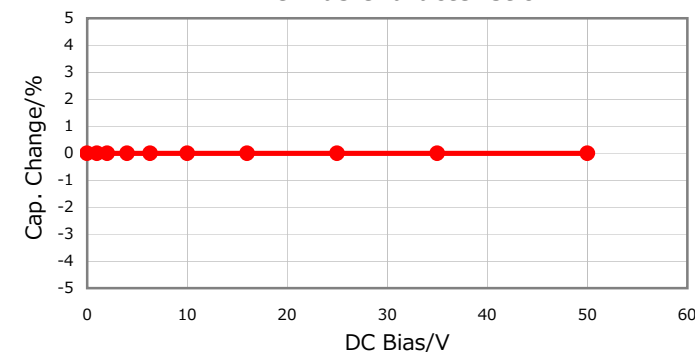

Cap. vs. Freq. Characteristic

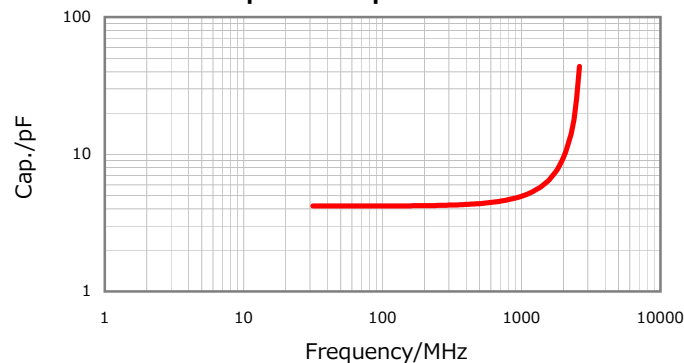

Temperature Characteristics

