

# MC78PC00 Series

## Low Noise 150 mA Low Drop Out (LDO) Linear Voltage Regulator

The MC78PC00 are a series of CMOS linear voltage regulators with high output voltage accuracy, low supply current, low dropout voltage, and high Ripple Rejection. Each of these voltage regulators consists of an internal voltage reference, an error amplifier, resistors, a current limiting circuit and a chip enable circuit.

The dynamic Response to line and load is fast, which makes these products ideally suited for use in hand-held communication equipment. The MC78PC00 series are housed in the SOT-23 5 lead package, for maximum board space saving.

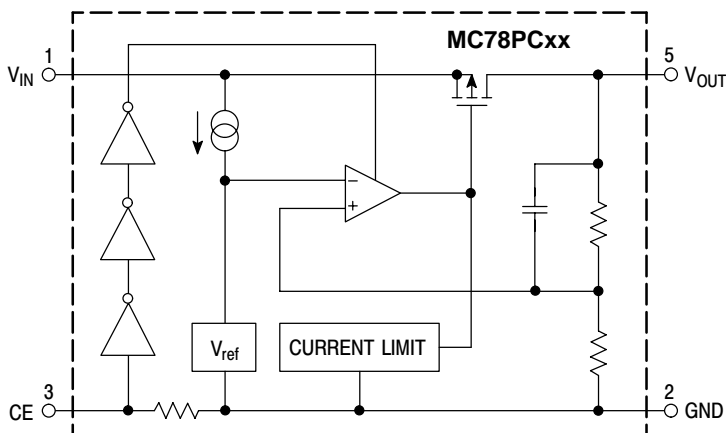
### MC78PC00 Features:

- Ultra-Low Supply Current: typical 35  $\mu$ A in ON mode with no load.
- Standby Mode: typical 0.1  $\mu$ A.
- Low Dropout Voltage: typical 0.2 V @  $I_{OUT} = 100$  mA.
- High Ripple Rejection: typical 70 dB @  $f = 1$  kHz.
- Low Temperature-Drift Coefficient of Output Voltage: typical  $\pm 100$  ppm/ $^{\circ}$ C.
- Excellent Line Regulation: typical 0.05%/V.
- High Accuracy Output Voltage:  $\pm 2.0\%$ .
- Fast Dynamic Response to Line and Load.
- Small Package: SOT-23 5 leads.
- Built-in Chip Enable circuit (CE input pin).
- Identical Pinout to the LP2980/1/2.
- Pb-Free Packages are Available

### MC78PC00 Applications:

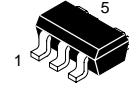
- Power source for cellular phones (GSM, CDMA, TDMA), Cordless Phones (PHS, DECT) and 2-way radios.
- Power source for domestic appliances such as cameras, VCRs and camcorders.
- Power source for battery-powered equipment.

### Block Diagram



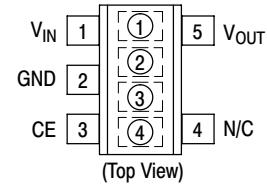
ON Semiconductor®

<http://onsemi.com>



SOT-23-5  
N SUFFIX  
CASE 1212

### PIN CONNECTIONS



### DEVICE MARKING

(4 digits are available for device marking)

Marking		Voltage Version
① ②	K8	1.8 V
	F5	2.5 V
	F8	2.8 V
	G0	3.0 V
	G3	3.3 V
③ ④	J0	5.0 V
		Lot Number

### PIN DESCRIPTION

Pin #	Symbol	Description
1	$V_{IN}$	Input Pin
2	GND	Ground Pin
3	CE	Chip Enable Pin
4	N/C	No Connection
5	$V_{OUT}$	Output Pin

### ORDERING INFORMATION

See detailed ordering and shipping information in the package dimensions section on page 14 of this data sheet.

# MC78PC00 Series

## MAXIMUM RATINGS

Rating	Symbol	Value	Unit
Input Voltage	$V_{IN}$	9.0	V
Input Voltage	$V_{CE}$	-0.3 ~ $V_{IN} + 0.3$	V
Output Voltage	$V_{OUT}$	-0.3 ~ $V_{IN} + 0.3$	V
Power Dissipation	$P_D$	250	mW
Operating Temperature Range	$T_A$	-40 to +85	°C
Operating Junction Temperature	$T_J$	+125	°C
Maximum Junction Temperature	$T_{Jmax}$	+150	°C
Storage Temperature Range	$T_{stg}$	-55 to +125	°C

Maximum ratings are those values beyond which device damage can occur. Maximum ratings applied to the device are individual stress limit values (not normal operating conditions) and are not valid simultaneously. If these limits are exceeded, device functional operation is not implied, damage may occur and reliability may be affected.

## ELECTRICAL CHARACTERISTICS ( $T_A = 25^\circ\text{C}$ )

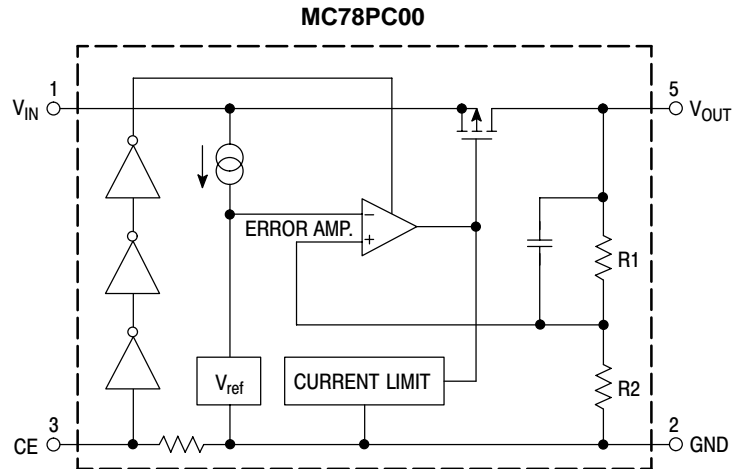
Characteristic	Symbol	Min	Typ	Max	Unit
Output Voltage ( $V_{IN} = V_{OUT} + 1.0\text{ V}$ , $I_{OUT} = 30\text{ mA}$ ) MC78PC18 MC78PC25 MC78PC28 MC78PC30 MC78PC33 MC78PC50	$V_{OUT}$	1.764 2.450 2.744 2.94 3.234 4.9	1.80 2.50 2.80 3.00 3.3 5.0	1.836 2.550 2.856 3.06 3.366 5.1	V
Nominal Output Current ( $V_{IN} = V_{OUT} + 1.0\text{ V}$ , $V_{OUT} = V_{OUT(nom)} - 0.1\text{ V}$ )	$I_{OUT}$	150	-	-	mA
Load Regulation ( $V_{IN} = V_{OUT} + 1.0\text{ V}$ , $1.0\text{ mA} \leq I_{OUT} \leq 80\text{ mA}$ )	$\Delta V_{OUT}/\Delta I_{OUT}$	-	12	40	mV
Supply Current in ON mode ( $V_{IN} = V_{OUT} + 1.0\text{ V}$ , $I_{OUT} = 0\text{ mA}$ )	$I_{SS}$	-	35	70	$\mu\text{A}$
Supply Current in OFF mode, i.e. $V_{CE} = \text{GND}$ ( $V_{IN} = V_{OUT} + 1.0\text{ V}$ , $I_{OUT} = 0\text{ mA}$ )	$I_{standby}$	-	0.1	1.0	$\mu\text{A}$
Ripple Rejection ( $f = 1.0\text{ kHz}$ , Ripple $0.5\text{ V}_{p-p}$ , $V_{IN} = V_{OUT} + 1.0\text{ V}$ )	RR	-	70	-	dB
Input Voltage	$V_{IN}$	-	-	8.0	V
Output Voltage Temperature Coefficient ( $I_{OUT} = 30\text{ mA}$ , $-40^\circ\text{C} \leq T_A \leq +85^\circ\text{C}$ )	$\Delta V_{OUT}/\Delta T$	-	$\pm 100$	-	ppm/°C
Short Circuit Current Limit ( $V_{OUT} = 0\text{ V}$ )	$I_{lim}$	-	50	-	mA
CE Pull-down Resistance	$R_{PD}$	2.5	5.0	10	$\text{M}\Omega$
CE Input Voltage "H" (ON Mode)	$V_{IH}$	1.5	-	$V_{IN}$	V
CE Input Voltage "L" (OFF Mode)	$V_{IL}$	0	-	0.25	V
Output Noise Voltage ( $f = 10\text{ Hz to } 100\text{ kHz}$ )	$e_n$	-	30	-	$\mu\text{V}_{rms}$

## ELECTRICAL CHARACTERISTICS by OUTPUT VOLTAGE $V_{OUT}$ ( $T_A = 25^\circ\text{C}$ )

Characteristic	Symbol	Min	Typ	Max	Unit
Dropout Voltage ( $I_{OUT} = 100\text{ mA}$ ) $1.8 \leq V_{OUT} \leq 1.9$ $2.0 \leq V_{OUT} \leq 2.4$ $2.5 \leq V_{OUT} \leq 2.7$ $2.8 \leq V_{OUT} \leq 3.3$ $3.4 \leq V_{OUT} \leq 6.0$	$V_{DIF}$	- - - - -	0.60 0.35 0.24 0.20 0.17	1.40 0.70 0.35 0.30 0.26	V
Line Regulation ( $V_{OUT} + 0.5\text{ V} \leq V_{IN} \leq 8.0\text{ V}$ , $I_{OUT} = 30\text{ mA}$ )	$\Delta V_{OUT}/\Delta V_{IN}$	-	0.05	0.20	%/V

# MC78PC00 Series

## OPERATION



In the MC78PC00, the output voltage  $V_{OUT}$  is detected by R1, R2. The detected output voltage is then compared to the internal voltage reference by the error amplifier. Both a current limiting circuit for short circuit protection, and a chip enable circuit are included.

# MC78PC00 Series

## TEST CIRCUITS

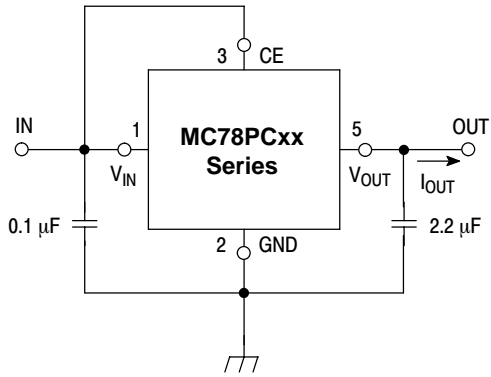


Figure 1. Standard Test Circuits

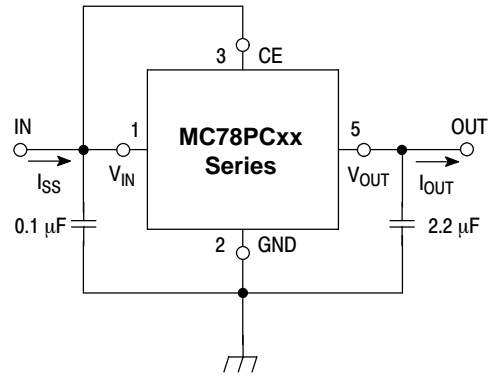


Figure 2. Supply Current Test Circuit

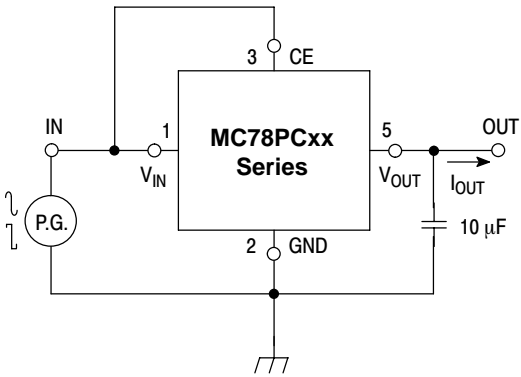


Figure 3. Ripple Rejection, Line Transient Response Test Circuit

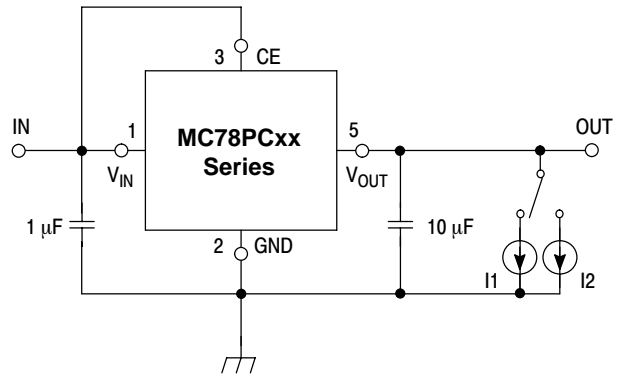
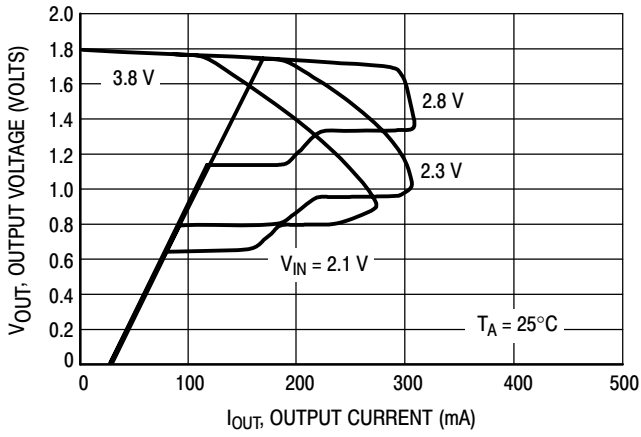
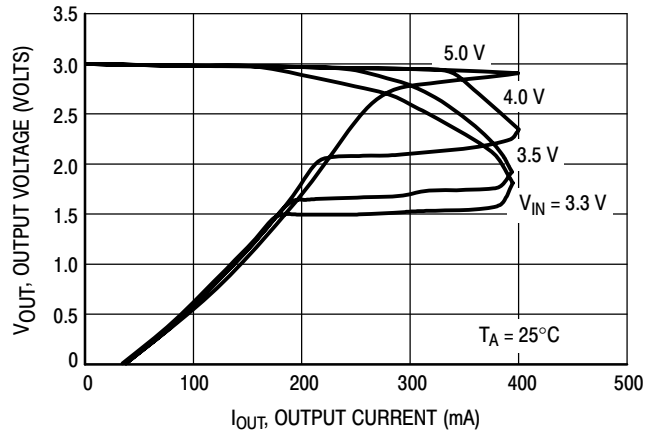


Figure 4. Load Transient Response Test Circuit

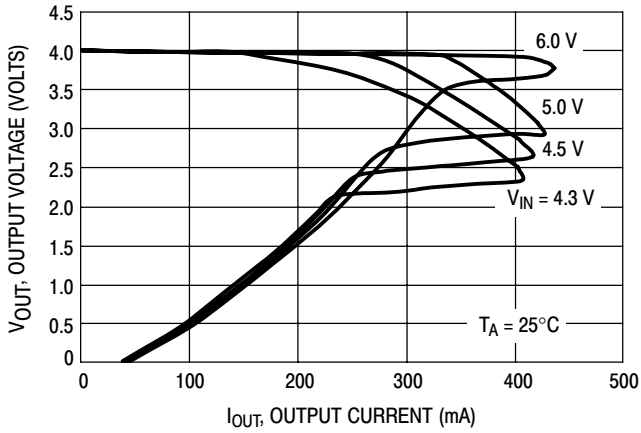
# MC78PC00 Series



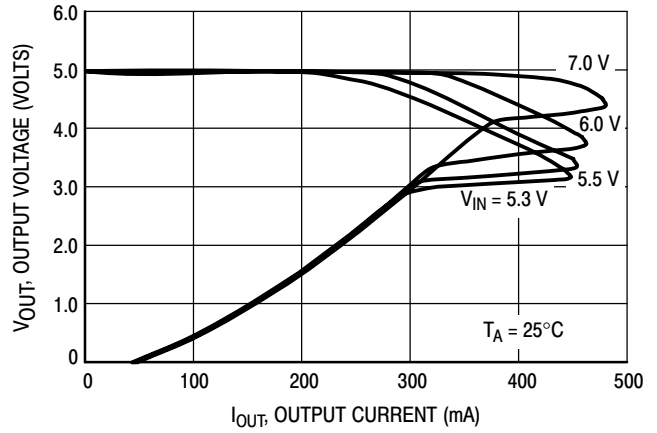
**Figure 5. MC78PC18 Output Voltage versus Output Current**



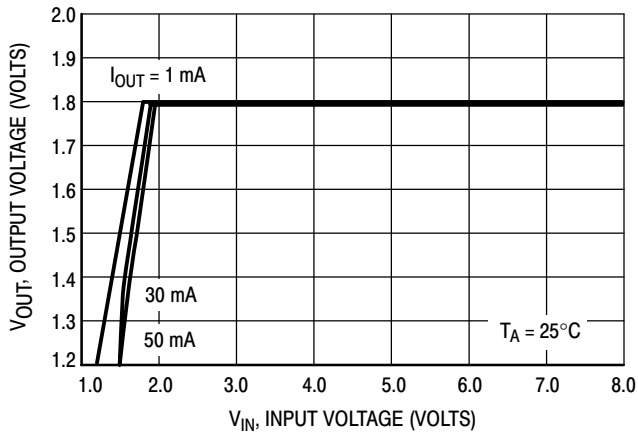
**Figure 6. MC78PC30 Output Voltage versus Output Current**



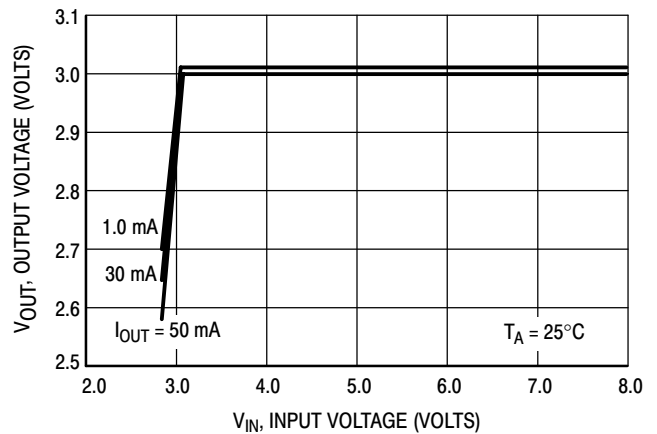
**Figure 7. MC78PC40 (4.0 V) Output Voltage versus Output Current**



**Figure 8. MC78PC50 Output Voltage versus Output Current**



**Figure 9. MC78PC18 Output Voltage versus Input Voltage**



**Figure 10. MC78PC30 Output Voltage versus Input Voltage**

# MC78PC00 Series

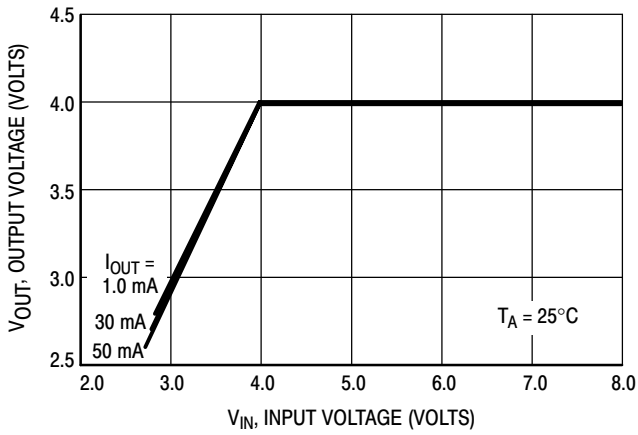


Figure 11. MC78PC40 (4.0 V) Output Voltage versus Input Voltage

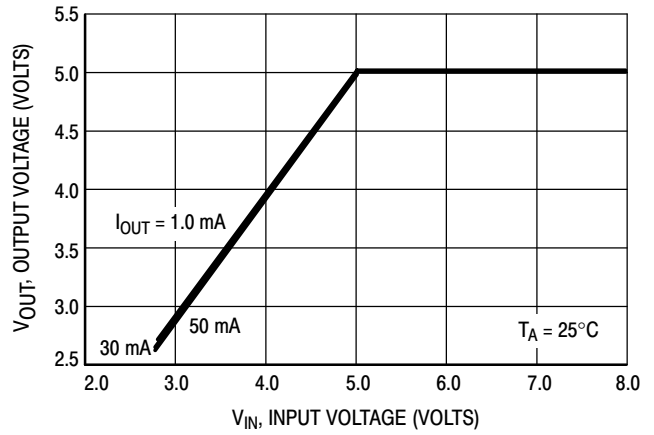


Figure 12. MC78PC50 Output Voltage versus Input Voltage

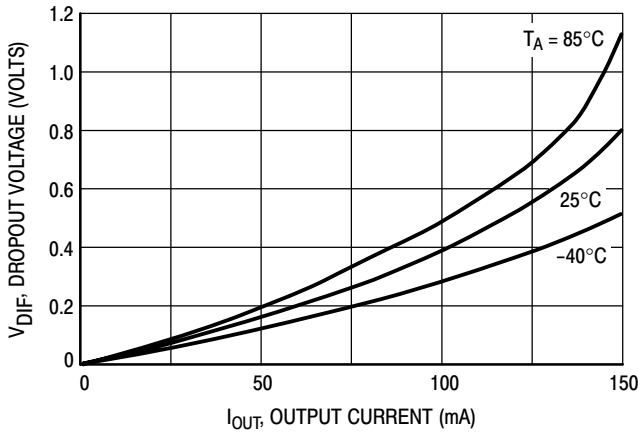


Figure 13. MC78PC18 Dropout Voltage versus Output Current

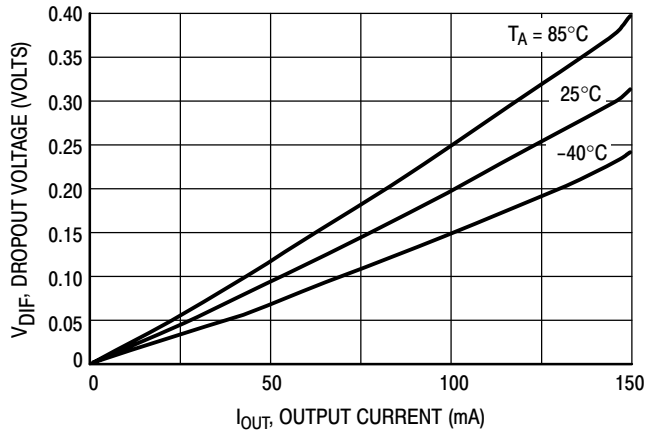


Figure 14. MC78PC30 Dropout Voltage versus Output Current

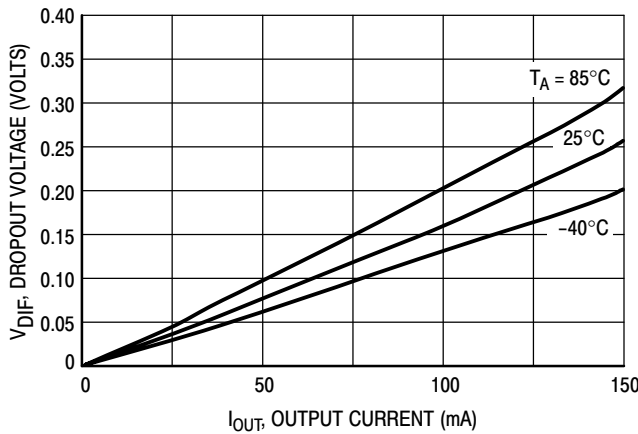


Figure 15. MC78PC40 (4.0 V) Dropout Voltage versus Output Current

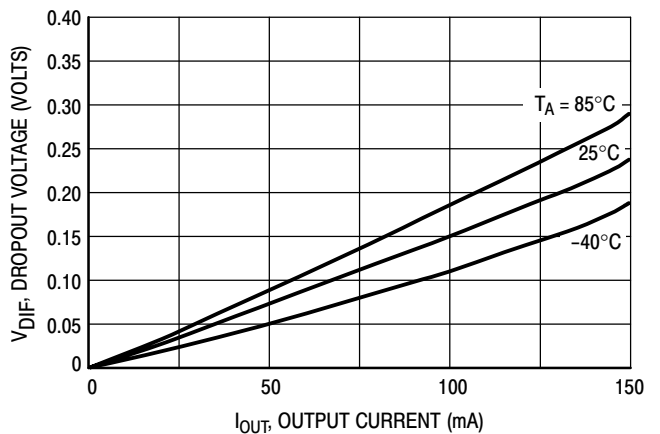
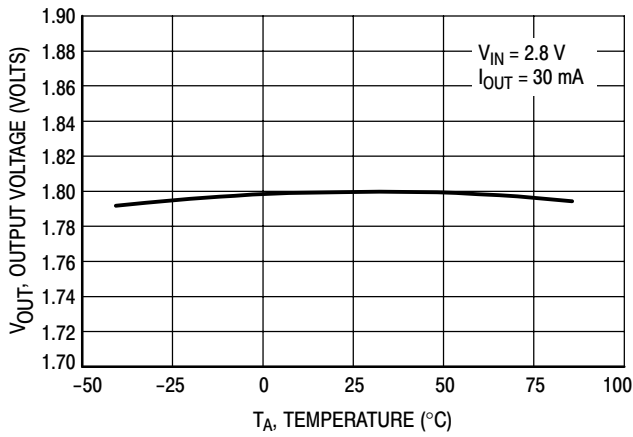
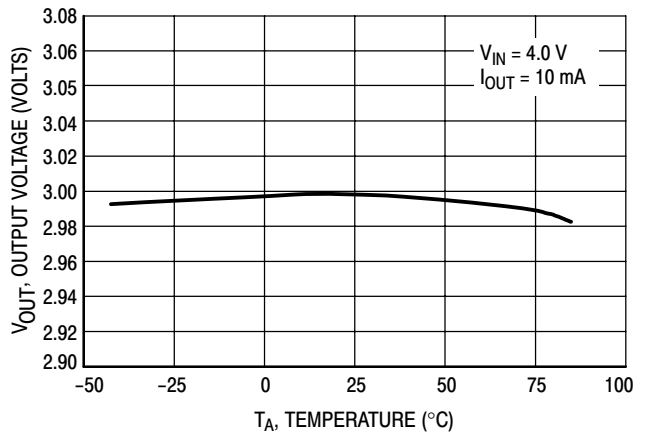


Figure 16. MC78PC50 Dropout Voltage versus Output Current

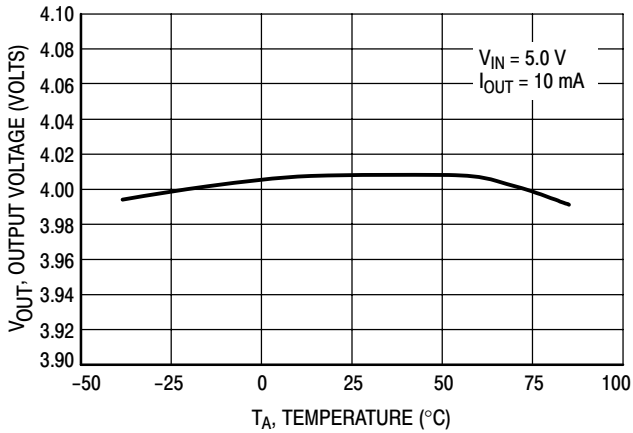
# MC78PC00 Series



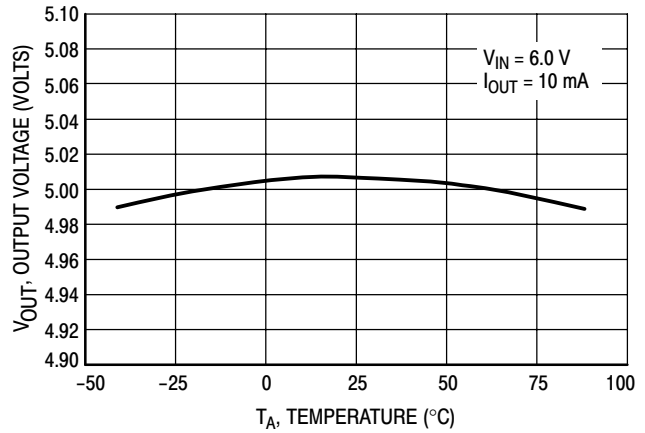
**Figure 17. MPC78PC18 Output Voltage versus Temperature**



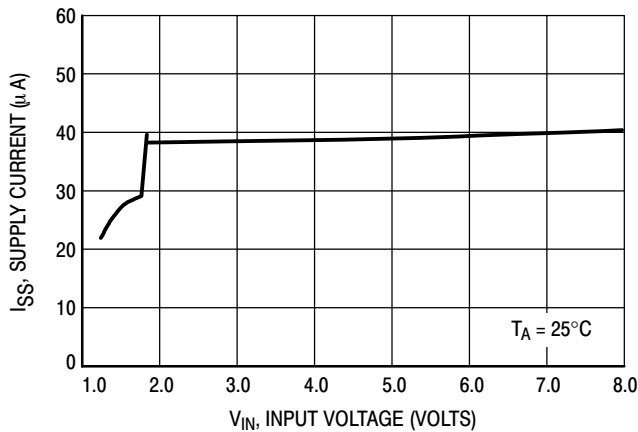
**Figure 18. MC78PC30 Output Voltage versus Temperature**



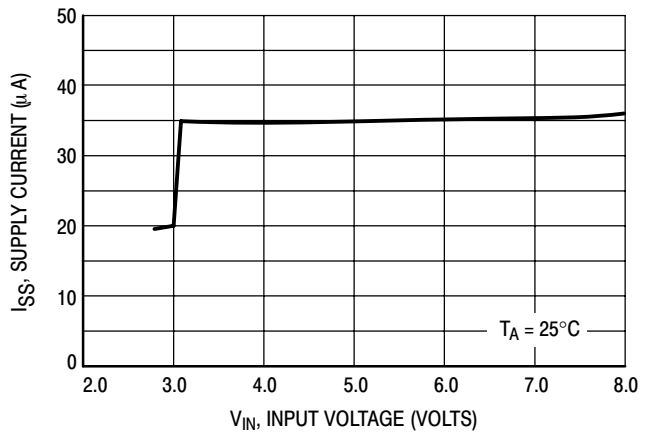
**Figure 19. MC78PC40 (4.0 V) Output Voltage versus Temperature**



**Figure 20. MC78PC50 Output Voltage versus Temperature**

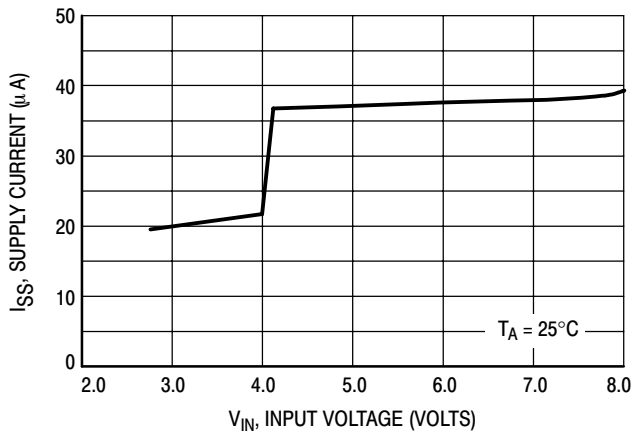


**Figure 21. MC78PC18 Supply Current versus Input Voltage**

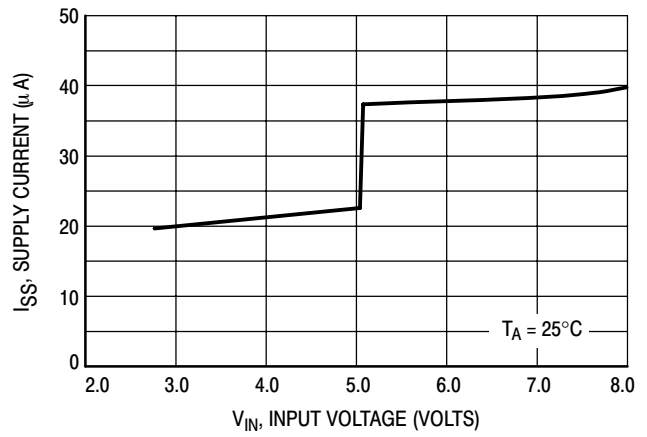


**Figure 22. MC78PC30 Supply Current versus Input Voltage**

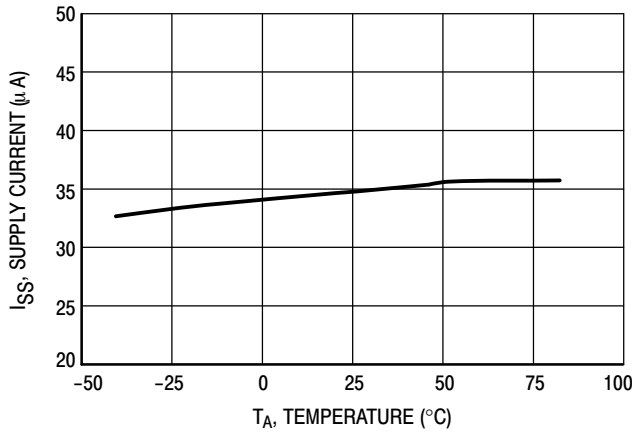
# MC78PC00 Series



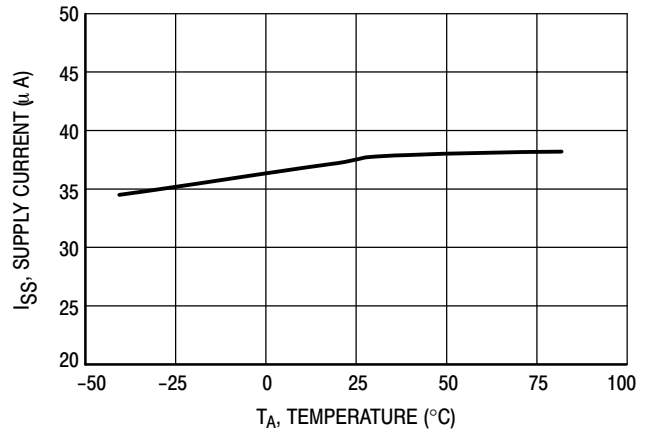
**Figure 23. MC78PC40 (4.0 V) Supply Current versus Input Voltage**



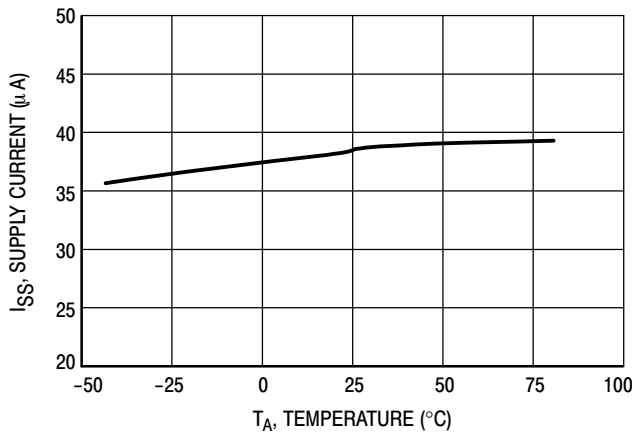
**Figure 24. MC78PC50 Supply Current versus Input Voltage**



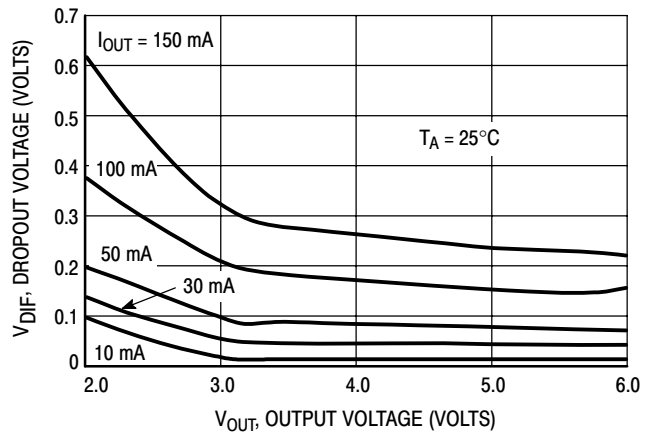
**Figure 25. MC78PC30 Supply Current versus Temperature**



**Figure 26. MC78PC40 (4.0 V) Supply Current versus Temperature**



**Figure 27. MC78PC50 Supply Current versus Temperature**



**Figure 28. Dropout Voltage versus Output Voltage**



# MC78PC00 Series

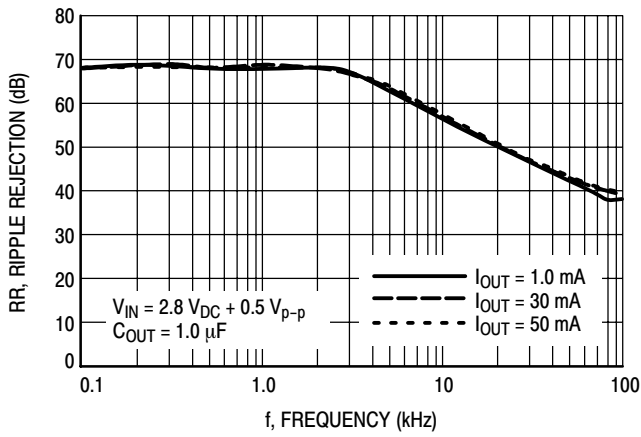


Figure 29. MC78PC18 Ripple Rejection versus Frequency

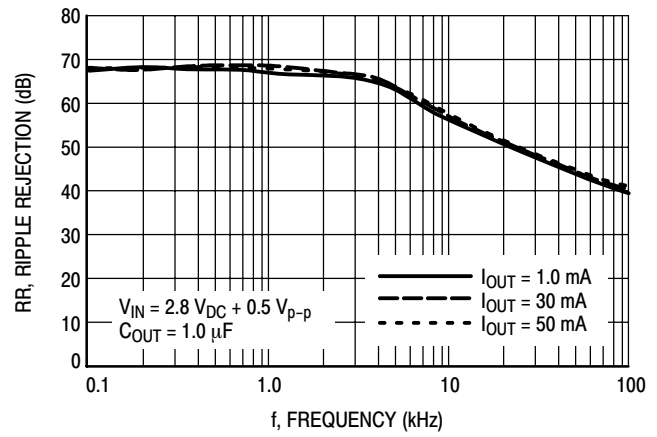


Figure 30. MC78PC18 Ripple Rejection versus Frequency

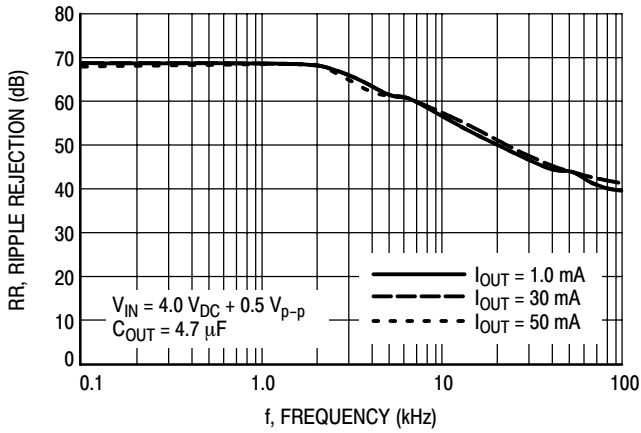


Figure 31. MC78PC30 Ripple Rejection versus Frequency

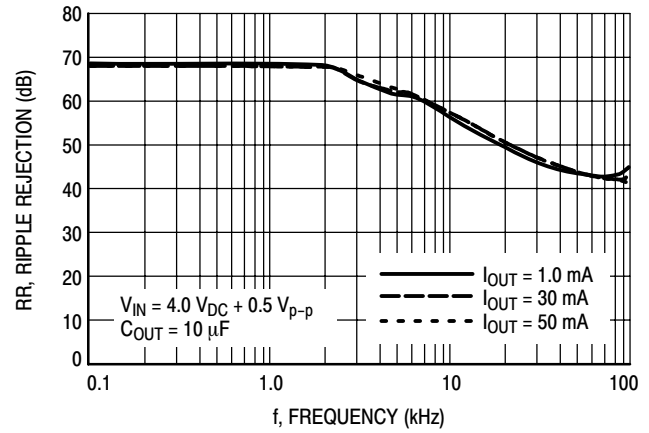


Figure 32. MC78PC30 Ripple Rejection versus Frequency

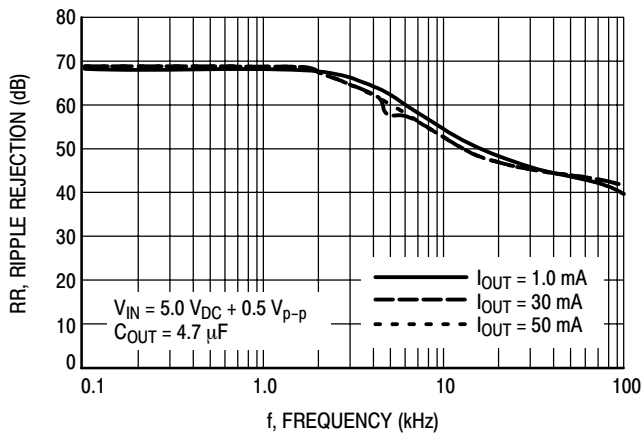


Figure 33. MC78PC40 (4.0 V) Ripple Rejection versus Frequency

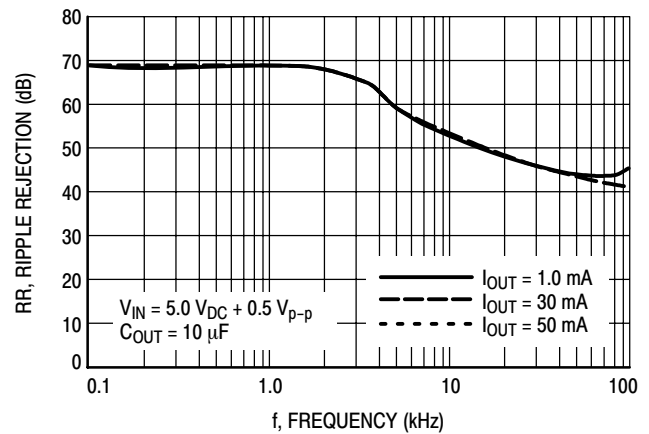


Figure 34. MC78PC40 (4.0 V) Ripple Rejection versus Frequency

# MC78PC00 Series

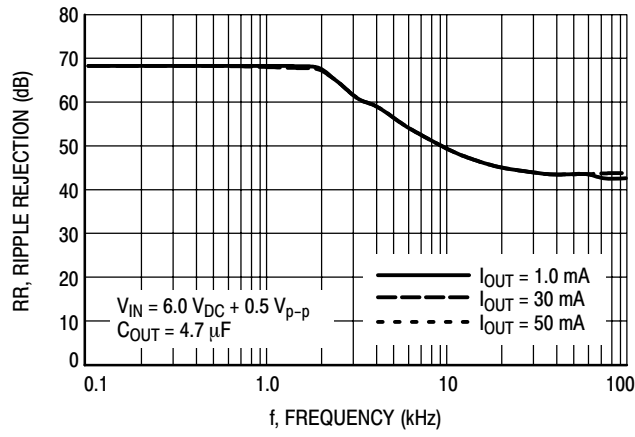


Figure 35. MC78PC50 Ripple Rejection versus Frequency

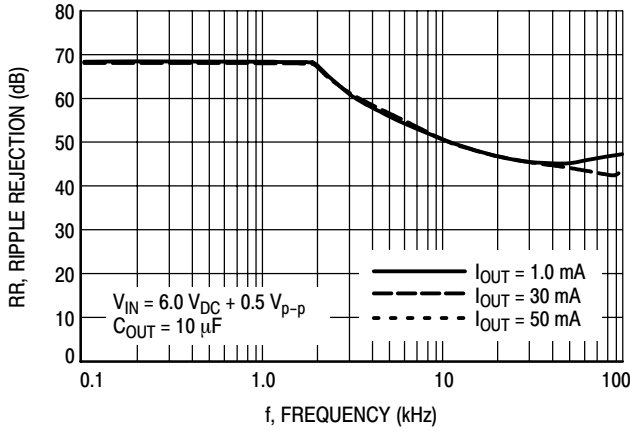


Figure 36. MC78PC50 Ripple Rejection versus Frequency

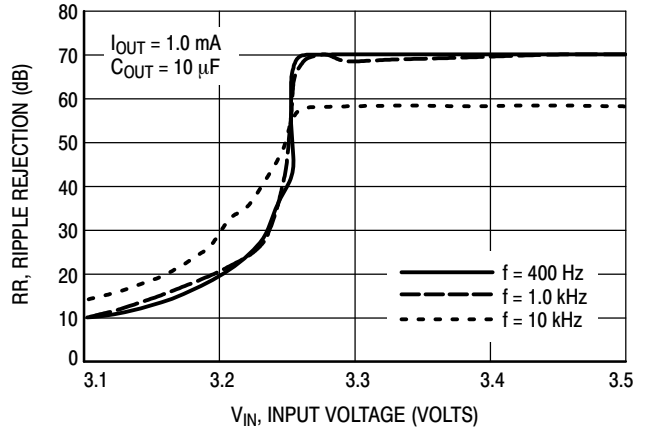


Figure 37. MC78PC30 Ripple Rejection versus Input Voltage (DC Bias)

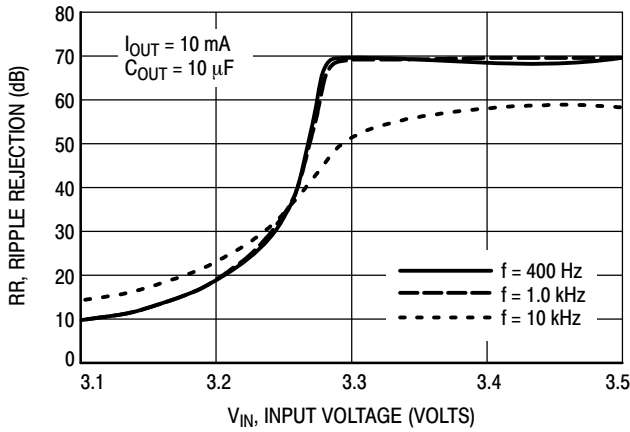


Figure 38. MC78PC30 Ripple Rejection versus Input Voltage (DC Bias)

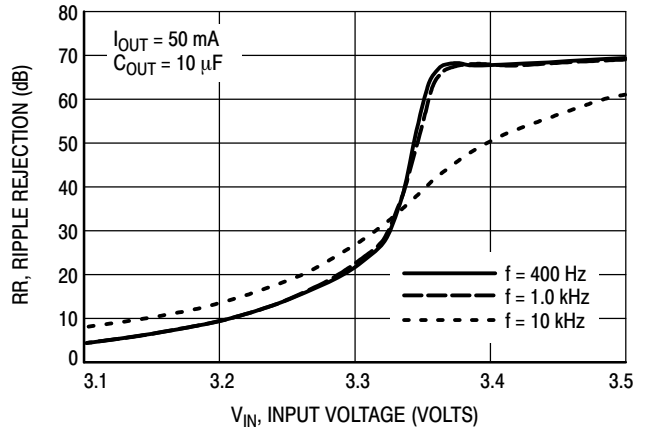


Figure 39. MC78PC30 Ripple Rejection versus Input Voltage (DC Bias)

# MC78PC00 Series

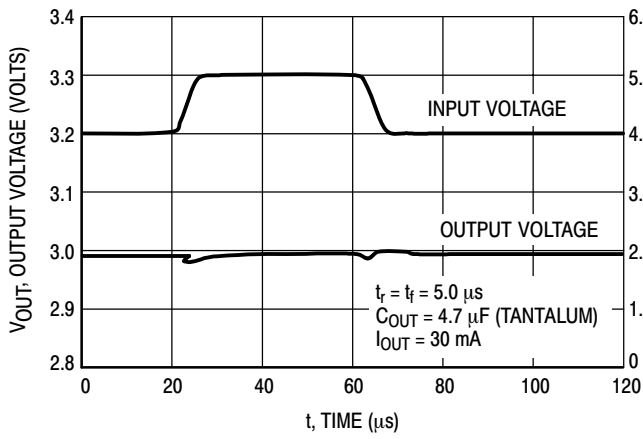


Figure 40. MC78PC30 Line Transient Response

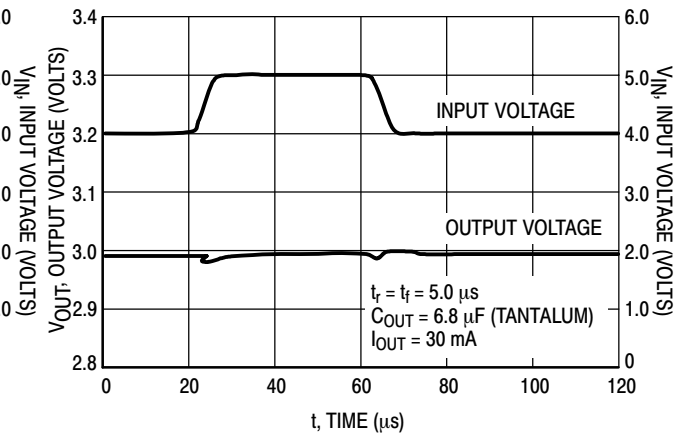


Figure 41. MC78PC30 Line Transient Response

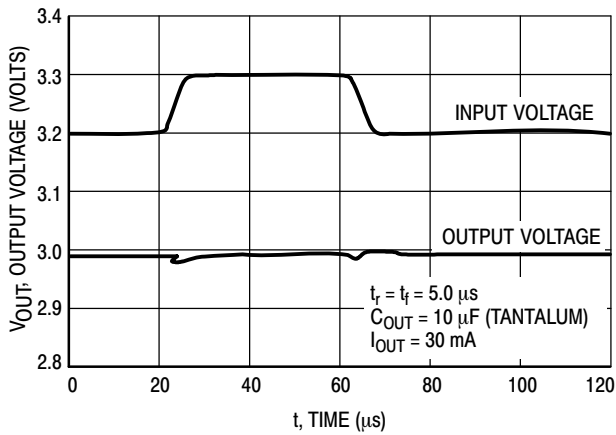


Figure 42. MC78PC30 Line Transient Response

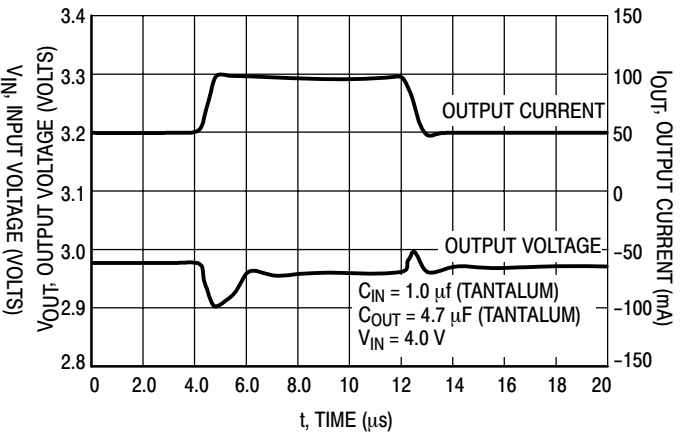


Figure 43. MC78PC30 Load Transient Response

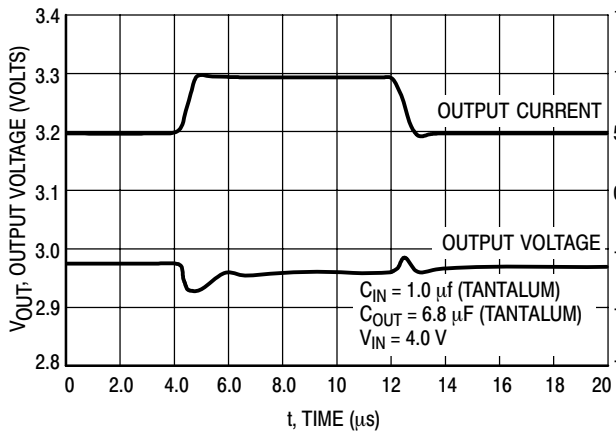


Figure 44. MC78PC30 Load Transient Response

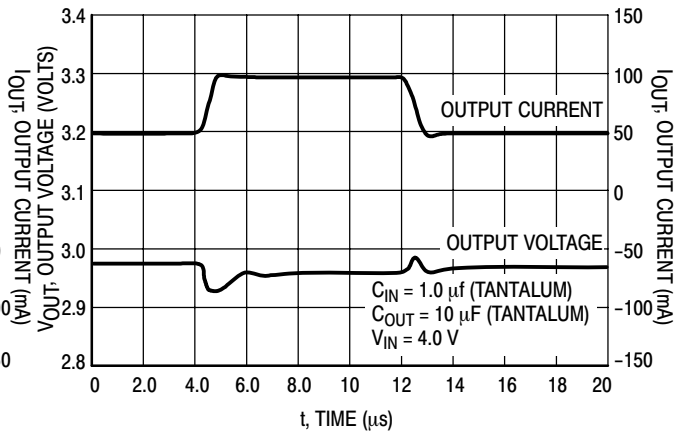


Figure 45. MC78PC30 Load Transient Response

# MC78PC00 Series

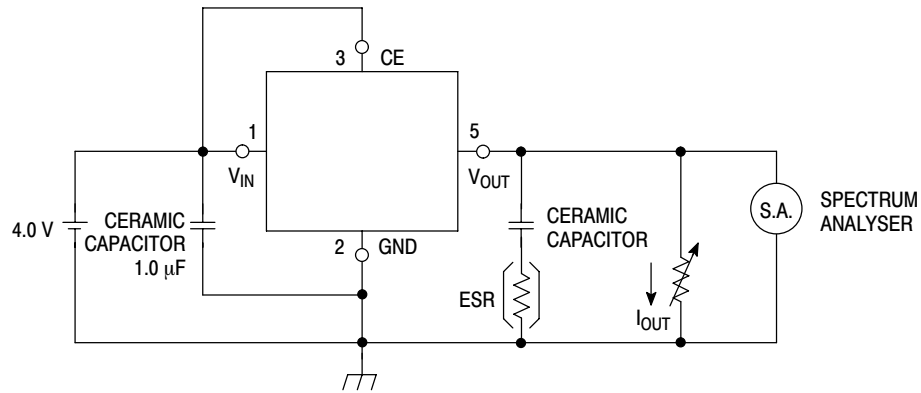
## APPLICATION HINTS

When using these circuits, please be sure to observe the following points:

- Phase compensation is made for securing stable operation even if the load current varies. For this reason, be sure to use a capacitor  $C_{OUT}$  with good frequency characteristics and ESR (Equivalent Series Resistance) as described in the graphs on page 11.

On page 11, the relations between  $I_{OUT}$  (Output Current)

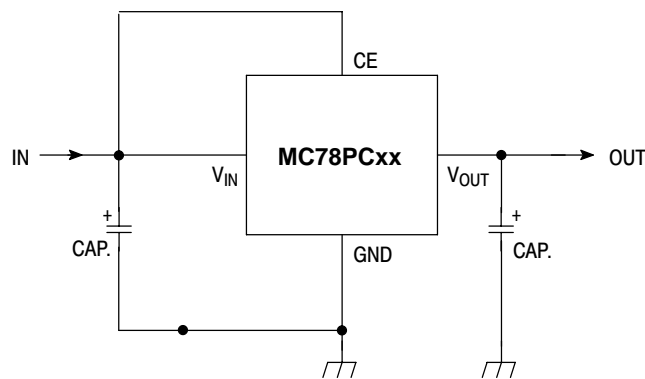
and ESR of Output Capacitor are shown. The conditions where the white noise level is under  $40 \mu V$  (Avg.) are marked by the shaded area in the graph. (note: When additional ceramic capacitors are connected to the Output Pin with Output capacitor for phase compensation, there is a possibility that the operation will be unstable. Because of this, test these circuits with as same external components as ones to be used on the PCB).



MEASURING CONDITIONS: (1) FREQUENCY RANGE: 10 Hz TO 1.0 MHz  
(2) TEMPERATURE: 25°C

**Figure 46. Measuring Circuit for White Noise: MC78PC30**

- Please be sure the  $V_{in}$  and GND lines are sufficiently wide. When the impedance of these lines is high, there is a chance to pick up noise or to malfunction.
- Connect the capacitor with a capacitance of  $1.0 \mu F$  or more between  $V_{in}$  and GND as close as possible to  $V_{in}$  or GND.
- Set external components, especially the Output Capacitor, as close as possible to the circuit, and make the wiring as short as possible.



**Figure 47. Typical Application**

# MC78PC00 Series

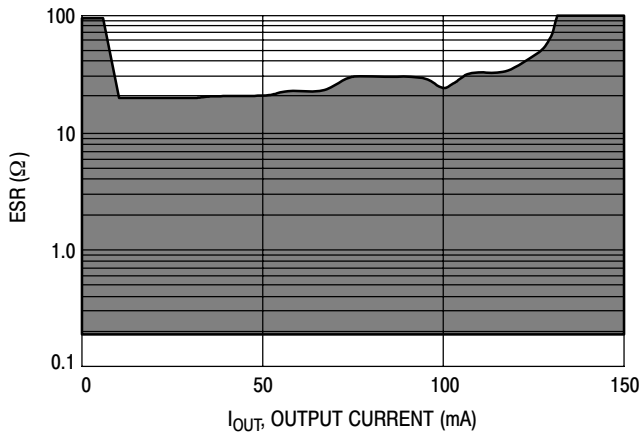


Figure 48. Ceramic Capacitor 4.7  $\mu$ F

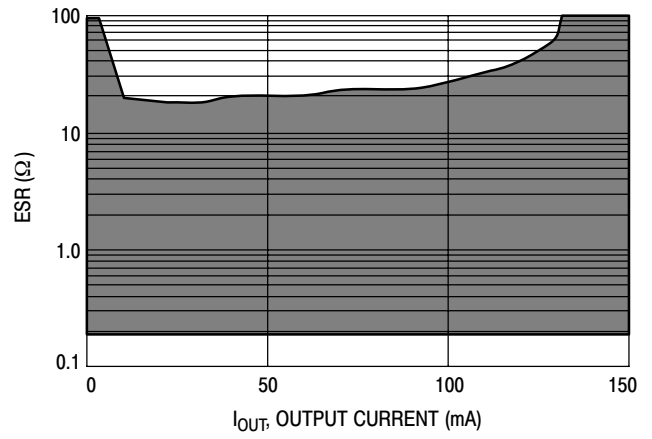


Figure 49. Ceramic Capacitor 6.8  $\mu$ F

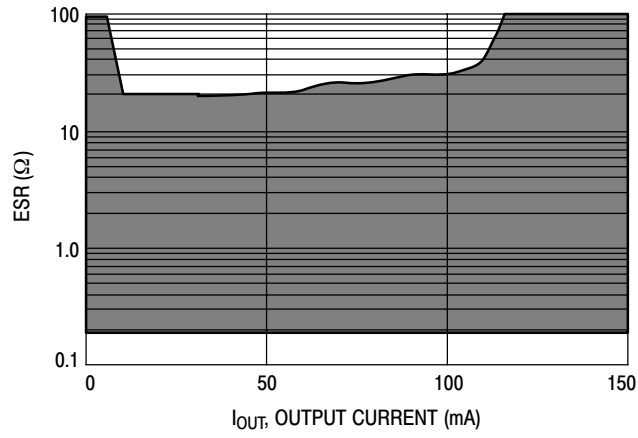
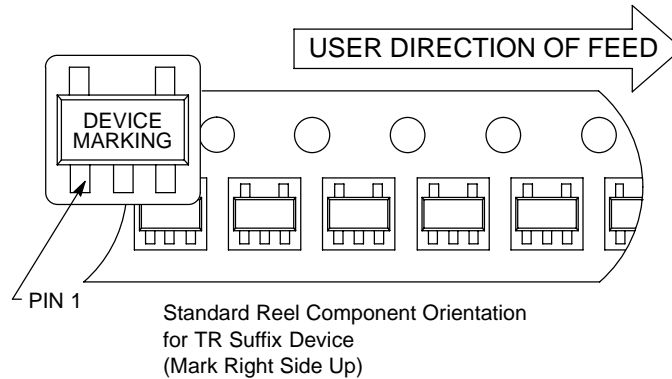


Figure 50. Ceramic Capacitor 10  $\mu$ F

# MC78PC00 Series

## TAPE AND REEL INFORMATION

### Component Taping Orientation for 5L SOT-23 Devices



**Tape & Reel Specifications Table**

Package	Tape Width (W)	Pitch (P)	Part Per Full Reel	Reel Diameter
5L SOT-23	8 mm	4 mm	3000	7 inches

## ORDERING INFORMATION

Device	Package	Shipping <sup>†</sup>
MC78PC18NTR	SOT-23 5 Leads	3000 Units/Tape & Reel
MC78PC18NTRG	SOT-23 5 Leads (Pb-Free)	
MC78PC25NTR	SOT-23 5 Leads	
MC78PC25NTRG	SOT-23 5 Leads (Pb-Free)	
MC78PC28NTR	SOT-23 5 Leads	
MC78PC28NTRG	SOT-23 5 Leads (Pb-Free)	
MC78PC30NTR	SOT-23 5 Leads	
MC78PC30NTRG	SOT-23 5 Leads (Pb-Free)	
MC78PC33NTR	SOT-23 5 Leads	
MC78PC33NTRG	SOT-23 5 Leads (Pb-Free)	
MC78PC50NTR	SOT-23 5 Leads	
MC78PC50NTRG	SOT-23 5 Leads (Pb-Free)	

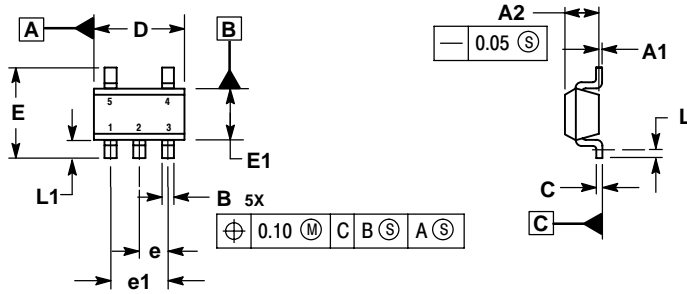
<sup>†</sup>For information on tape and reel specifications, including part orientation and tape sizes, please refer to our Tape and Reel Packaging Specifications Brochure, BRD8011/D.

Other voltages are available. Consult your ON Semiconductor representative.

# MC78PC00 Series

## PACKAGE DIMENSIONS

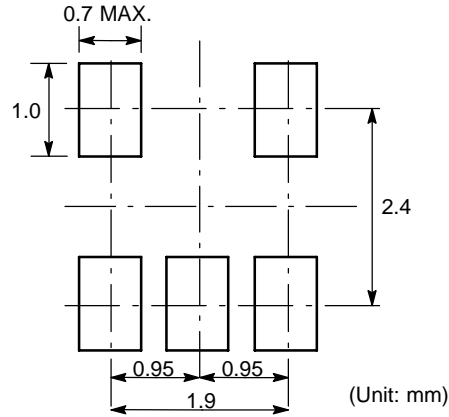
**SOT-23-5**  
**N SUFFIX**  
 PLASTIC PACKAGE  
 CASE 1212-01  
 ISSUE O



- NOTES:
1. DIMENSIONS ARE IN MILLIMETERS.
  2. INTERPRET DIMENSIONS AND TOLERANCES PER ASME Y14.5M, 1994.
  3. DATUM C IS A SEATING PLANE.

MILLIMETERS		
DIM	MIN	MAX
A1	0.00	0.10
A2	1.00	1.30
B	0.30	0.50
C	0.10	0.25
D	2.80	3.00
E	2.50	3.10
E1	1.50	1.80
e	0.95 BSC	
e1	1.90 BSC	
L	0.20	---
L1	0.45	0.75

### SOLDERING FOOTPRINT\*



**Figure 51. SOT-23-5**

\*For additional information on our Pb-Free strategy and soldering details, please download the ON Semiconductor Soldering and Mounting Techniques Reference Manual, SOLDERRM/D.

# MC78PC00 Series

**ON Semiconductor** and **ON** are registered trademarks of Semiconductor Components Industries, LLC (SCILLC). SCILLC reserves the right to make changes without further notice to any products herein. SCILLC makes no warranty, representation or guarantee regarding the suitability of its products for any particular purpose, nor does SCILLC assume any liability arising out of the application or use of any product or circuit, and specifically disclaims any and all liability, including without limitation special, consequential or incidental damages. "Typical" parameters which may be provided in SCILLC data sheets and/or specifications can and do vary in different applications and actual performance may vary over time. All operating parameters, including "Typicals" must be validated for each customer application by customer's technical experts. SCILLC does not convey any license under its patent rights nor the rights of others. SCILLC products are not designed, intended, or authorized for use as components in systems intended for surgical implant into the body, or other applications intended to support or sustain life, or for any other application in which the failure of the SCILLC product could create a situation where personal injury or death may occur. Should Buyer purchase or use SCILLC products for any such unintended or unauthorized application, Buyer shall indemnify and hold SCILLC and its officers, employees, subsidiaries, affiliates, and distributors harmless against all claims, costs, damages, and expenses, and reasonable attorney fees arising out of, directly or indirectly, any claim of personal injury or death associated with such unintended or unauthorized use, even if such claim alleges that SCILLC was negligent regarding the design or manufacture of the part. SCILLC is an Equal Opportunity/Affirmative Action Employer. This literature is subject to all applicable copyright laws and is not for resale in any manner.

## PUBLICATION ORDERING INFORMATION

### LITERATURE FULFILLMENT:

Literature Distribution Center for ON Semiconductor  
P.O. Box 61312, Phoenix, Arizona 85082-1312 USA  
**Phone:** 480-829-7710 or 800-344-3860 Toll Free USA/Canada  
**Fax:** 480-829-7709 or 800-344-3867 Toll Free USA/Canada  
**Email:** [orderlit@onsemi.com](mailto:orderlit@onsemi.com)

**N. American Technical Support:** 800-282-9855 Toll Free  
USA/Canada

**Japan:** ON Semiconductor, Japan Customer Focus Center  
2-9-1 Kamimeguro, Meguro-ku, Tokyo, Japan 153-0051  
**Phone:** 81-3-5773-3850

**ON Semiconductor Website:** <http://onsemi.com>

**Order Literature:** <http://www.onsemi.com/litorder>

For additional information, please contact your  
local Sales Representative.