

# TVS Diode Arrays

Electronic Protection Array for ESD and Overvoltage Protection

## SP723

The SP723 is an array of SCR/Diode bipolar structures for ESD and over-voltage protection of sensitive input circuits. The SP723 has 2 protection SCR/Diode device structures per input. There are a total of 6 available inputs that can be used to protect up to 6 external signal or bus lines. Over-voltage protection is from the IN (Pins 1 - 3 and Pins 5 - 7) to V+ or V-.

The SCR structures are designed for fast triggering at a threshold of one  $+V_{BE}$  diode threshold above V+ (Pin 8) or a  $-V_{BE}$  diode threshold below V- (Pin 4). From an IN input, a clamp to V+ is activated if a transient pulse causes the input to be increased to a voltage level greater than one  $V_{BE}$  above V+. A similar clamp to V- is activated if a negative pulse, one  $V_{BE}$  less than V-, is applied to an IN input.

Refer to Fig 1 and Table 1 for further details. Refer to Application Note AN9304 and AN9612 for further detail.

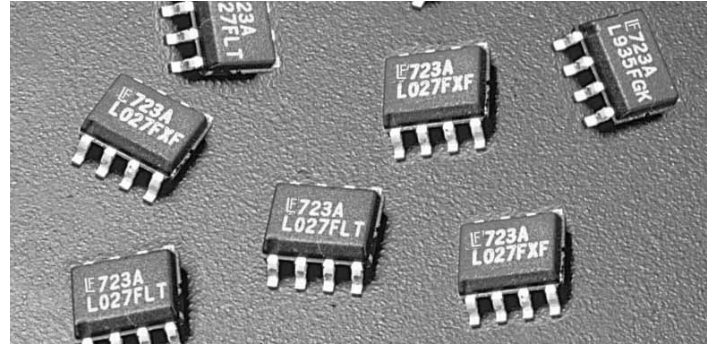

### Ordering Information

PART NUMBER	TEMP. RANGE (°C)	PACKAGE	PKG. NO.	Min. Order Qty.
SP723AP	-40 to 105	8 Ld PDIP	E8.3	2000
SP723AB	-40 to 105	8 Ld SOIC	M8.15	1960
SP723ABT	-40 to 105	8 Ld SOIC Tape and Reel	M8.15	2500

### Features

- ESD Interface per HBM Standards
  - IEC 61000-4-2, Direct Discharge ..... 8kV (Level 4)
  - IEC 61000-4-2, Air Discharge ..... 15kV (Level 4)
  - MIL-STD-3015.7 ..... 25kV
- Peak Current Capability
  - IEC 61000-4-5 8/20µs Peak Pulse Current. .... ±7A
  - Single Transient Pulse, 100s Pulse Width. .... ±4A
- Designed to Provide Over-Voltage Protection
  - Single-Ended Voltage Range to ..... +30V
  - Differential Voltage Range to ..... ±15V
- Fast Switching ..... 2ns Risetime
- Low Input Leakages ..... 2nA at 25°C Typical
- Low Input Capacitance ..... 5pF Typical
- An Array of 6 SCR/Diode Pairs
- Operating Temperature Range ..... -40°C to 105°C

### Functional Diagram

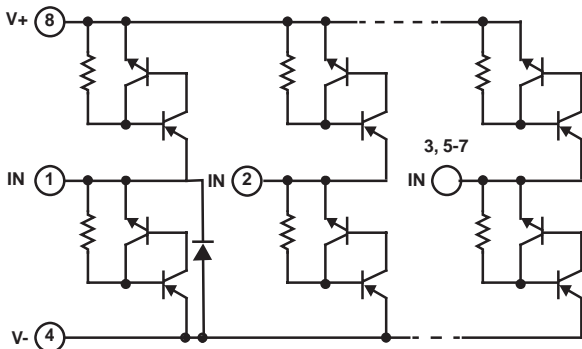

### Applications

- Microprocessor/Logic Input Protection
- Data Bus Protection
- Analog Device Input Protection
- Voltage Clamp

### Pinout

SP723  
(PDIP, SOIC)  
TOP VIEW

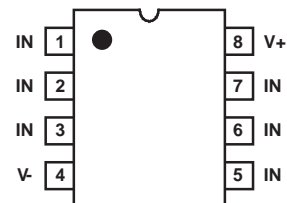

# TVS Diode Arrays

Electronic Protection Array for ESD and Overvoltage Protection

## SP723

### Absolute Maximum Ratings

Continuous Supply Voltage, (V+) - (V-) . . . . . +35V  
 Forward Peak Current,  $I_{IN}$  to  $V_{CC}$ ;  $I_{IN}$  to GND  
 (Refer to Figure 6) . . . . . ±4A, 100µs  
 Peak Pulse Current, 8/20µs . . . . . ±7A  
 ESD Ratings and Capability (Figure 1, Table 1)  
 Load Dump and Reverse Battery (Note 2)

### Thermal Information

Thermal Resistance (Typical, Note 1)  $\theta_{JA}$  (°C/W)  
 PDIP Package . . . . . 160  
 SOIC Package . . . . . 170  
 Storage Temperature Range . . . . . -65°C to 150°C  
 Maximum Junction Temperature . . . . . 150°C  
 Lead Temperature (Soldering 10s) . . . . . 300°C  
 (SOIC - Lead Tips Only)

**CAUTION:** Stresses above those listed in “Absolute Maximum Ratings” may cause permanent damage to the device. This is a stress only rating and operation of the device at these or any other conditions above those indicated in the operational sections of this specification is not implied.

#### NOTE:

- $\theta_{JA}$  is measured with the component mounted on an evaluation PC board in free air.

### Electrical Specification $T_A = 40^\circ\text{C}$ to $105^\circ\text{C}$ , $V_{IN} = 0.5V_{CC}$ , Unless Otherwise Specified

PARAMETER	SYMBOL	TEST CONDITIONS	MIN	TYP	MAX	UNITS
Operating Voltage Range, $V_{SUPPLY} = [(V+) - (V-)]$	$V_{SUPPLY}$		-	2 to 30	-	V
Forward Voltage Drop IN to V-	$V_{FWDL}$	$I_{IN} = 2A$ (Peak Pulse)	-	2	-	V
IN to V+	$V_{FWDH}$		-	2	-	V
Input Leakage Current	$I_{IN}$		-20	5	+20	nA
Quiescent Supply Current	$I_{QUIESCENT}$		-	50	200	nA
Equivalent SCR ON Threshold		Note 3	-	1.1	-	V
Equivalent SCR ON Resistance		$V_{FWD}/I_{FWD}$ ; Note 3	-	0.5	-	$\Omega$
Input Capacitance	$C_{IN}$		-	5	-	pF
Input Switching Speed	$t_{ON}$		-	2	-	ns

#### NOTES:

- In automotive and battery operated systems, the power supply lines should be externally protected for load dump and reverse battery. When the V+ and V- Pins are connected to the same supply voltage source as the device or control line under protection, a current limiting resistor should be connected in series between the external supply and the SP723 supply pins to limit reverse battery current to within the rated maximum limits. Bypass capacitors of typically 0.01µF or larger from the V+ and V- Pins to ground are recommended.
- Refer to the Figure 3 graph for definitions of equivalent “SCR ON Threshold” and “SCR ON Resistance”. These characteristics are given here for thumb-rule information to determine peak current and dissipation under EOS conditions.

### ESD Capability

ESD capability is dependent on the application and defined test standard. The evaluation results for various test standards and methods based on Figure 1 are shown in Table 1.

The SP723 has a Level 4 HBM capability when tested as a device to the IEC 61000-4-2 standard. Level 4 specifies a required capability greater than 8kV for direct discharge and greater than 15kV for air discharge.

For the “Modified” MIL-STD-3015.7 condition that is defined as an “in-circuit” method of ESD testing, the V+ and V- pins have a return path to ground and the SP723 ESD capability is typically greater than 25kV from 100pF through 1.5k $\Omega$ . By strict definition of MIL-STD-3015.7 using “pin-to-pin” device testing, the ESD voltage capability is greater than 10kV.

For the SP723 EIAJ IC121 Machine Model (MM) standard, the ESD capability is typically greater than 2kV from 200pF with no series resistance.

TABLE 1. ESD TEST CONDITIONS

STANDARD	TYPE/MODE	$R_D$	$C_D$	$\pm V_D$
IEC 1000-4-2 (Level 4)	HBM, Air Discharge	330 $\Omega$	150pF	15kV
	HBM, Direct Discharge	330 $\Omega$	150pF	8kV
MIL-STD-3015.7	Modified HBM	1.5k $\Omega$	100pF	25kV
	Standard HBM	1.5k $\Omega$	100pF	10kV
EIAJ IC121	Machine Model	0k $\Omega$	200pF	2kV

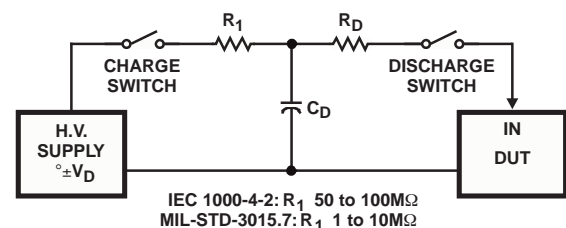

FIGURE 1. ELECTROSTATIC DISCHARGE TEST

# TVS Diode Arrays

Electronic Protection Array for ESD and Overvoltage Protection

## SP723

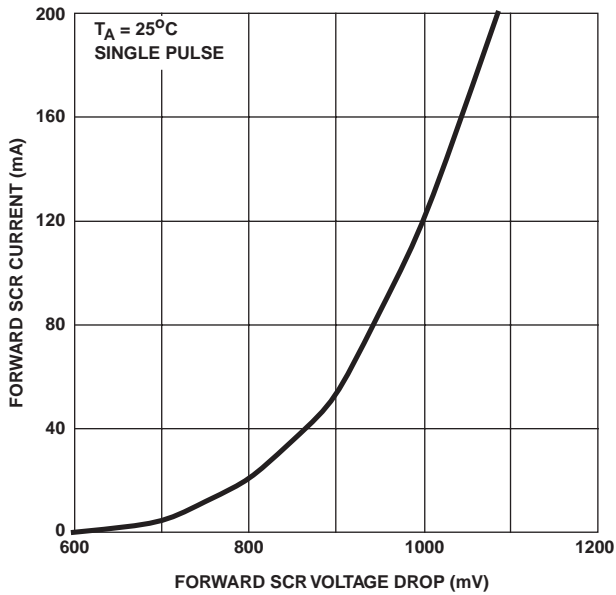

FIGURE 2. LOW CURRENT SCR FORWARD VOLTAGE DROP CURVE

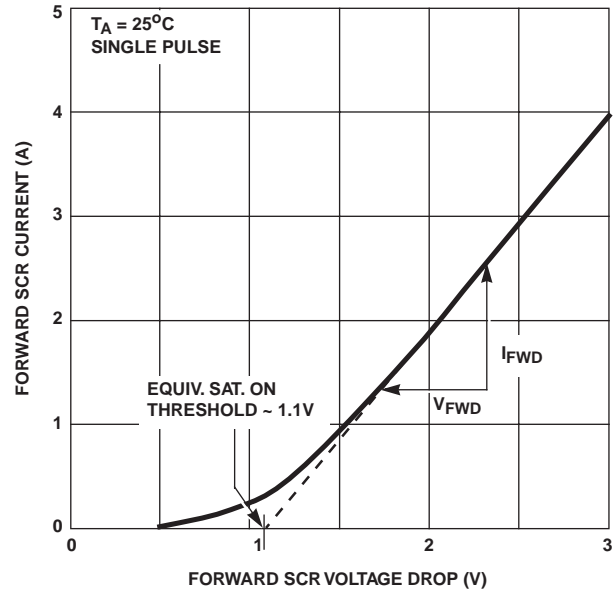

FIGURE 3. HIGH CURRENT SCR FORWARD VOLTAGE DROP CURVE

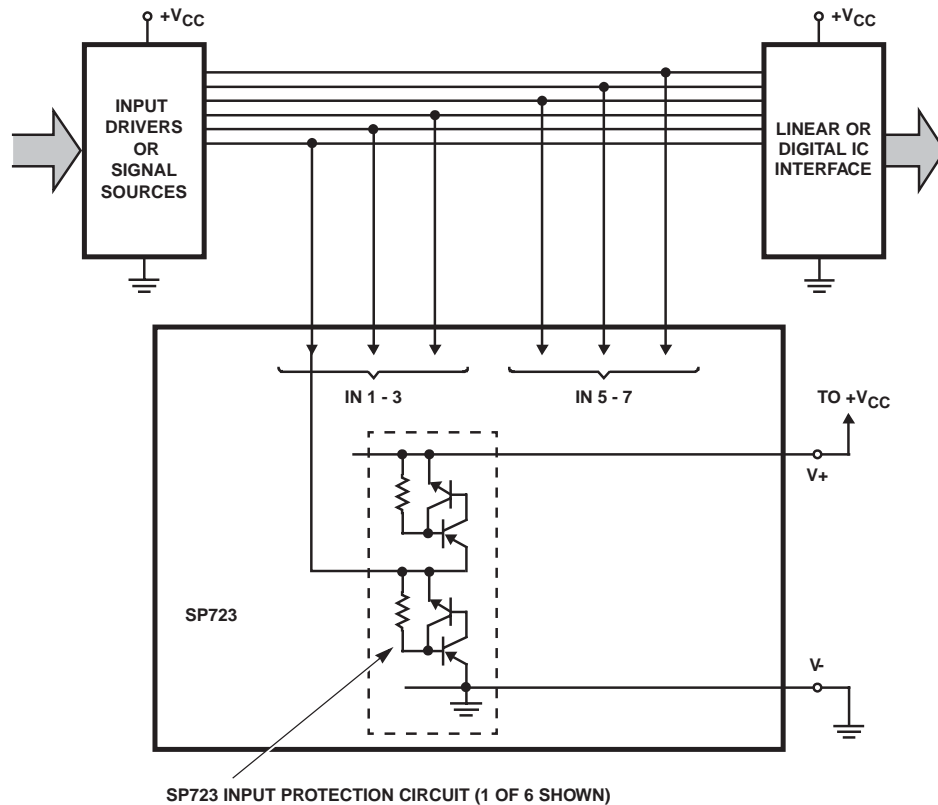

FIGURE 4. TYPICAL APPLICATION OF THE SP723 AS AN INPUT CLAMP FOR OVER-VOLTAGE, GREATER THAN  $1V_{BE}$  ABOVE  $V+$  OR LESS THAN  $-1V_{BE}$  BELOW  $V-$

# TVS Diode Arrays

Electronic Protection Array for ESD and Overvoltage Protection

## SP723

### Peak Transient Current Capability of the SP723

The peak transient current capability rises sharply as the width of the current pulse narrows. Destructive testing was done to fully evaluate the SP723's ability to withstand a wide range of peak current pulses vs time. The circuit used to generate current pulses is shown in Figure 5.

The test circuit of Figure 5 is shown with a positive pulse input. For a negative pulse input, the (-) current pulse input goes to an SP723 'IN' input pin and the (+) current pulse input goes to the SP723 V- pin. The V+ to V- supply of the SP723 must be allowed to float. (i.e., It is not tied to the ground reference of the current pulse generator.) Figure 6 shows the point of overstress as defined by increased leakage in excess of the data sheet published limits.

The maximum peak input current capability is dependent on the ambient temperature, improving as the temperature is reduced. Peak current curves are shown for ambient temperatures of 25°C and 105°C and a 15V power supply condition. The safe operating range of the transient peak current should be limited to no more than 75% of the measured overstress level for any given pulse width as shown in the curves of Figure 6.

Note that adjacent input pins of the SP723 may be paralleled to improve current (and ESD) capability. The sustained peak current capability is increased to nearly twice that of a single pin.

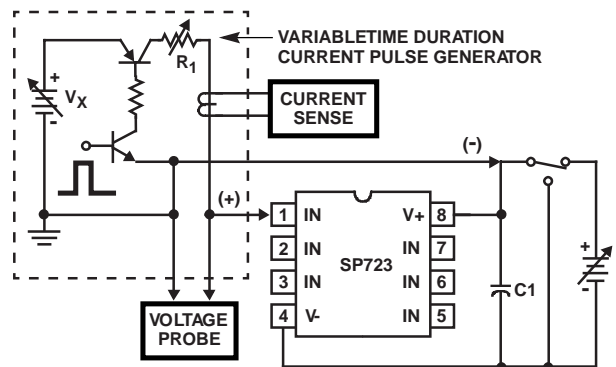

$R_1 \sim 10\Omega$  TYPICAL  
 $V_X$  ADJ. 10V/A TYPICAL  
 $C_1 \sim 100\mu F$

FIGURE 5. TYPICAL SP723 PEAK CURRENT TEST CIRCUIT WITH A VARIABLE PULSE WIDTH INPUT

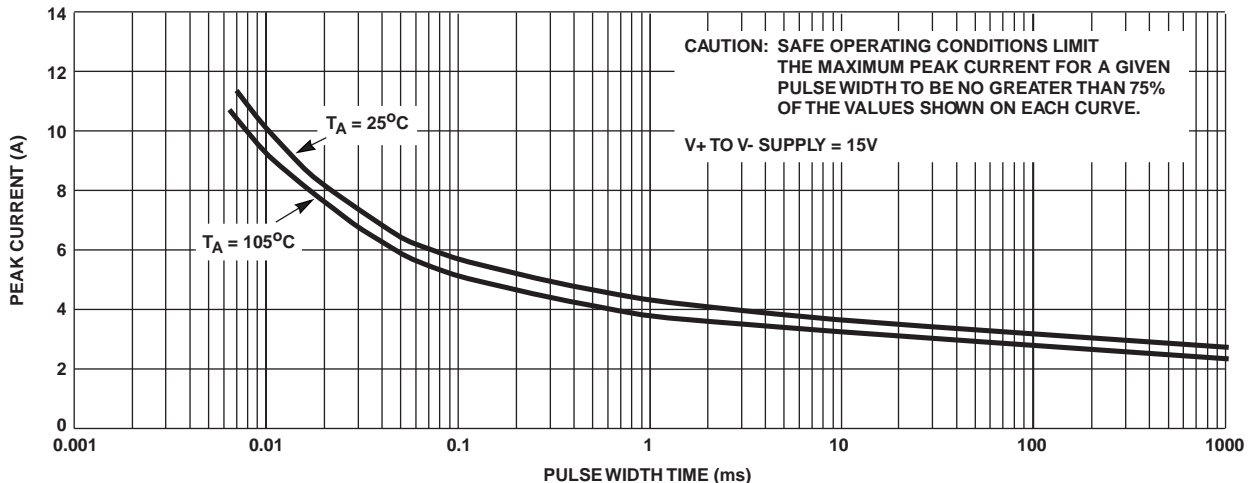

FIGURE 6. SP723 TYPICAL SINGLE PULSE PEAK CURRENT CURVES SHOWING THE MEASURED POINT OF OVERSTRESS IN AMPERES vs PULSE WIDTH TIME IN MILLISECONDS

# TVS Diode Arrays

Electronic Protection Array for ESD and Overvoltage Protection

## SP723

### Dual-In-Line Plastic Packages (PDIP)

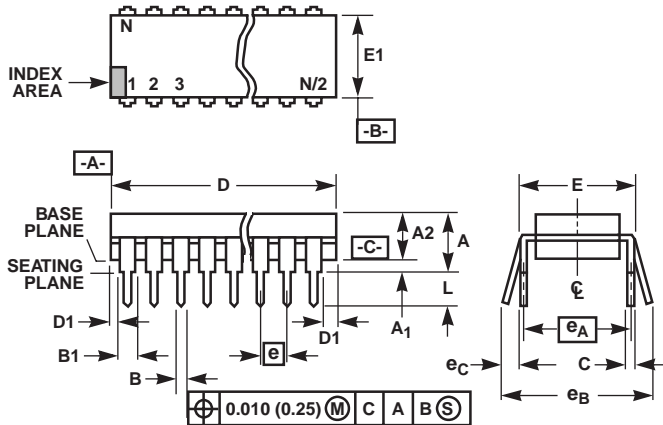

**NOTES:**

- Controlling Dimensions: INCH. In case of conflict between English and Metric dimensions, the inch dimensions control.
- Dimensioning and tolerancing per ANSI Y14.5M-1982.
- Symbols are defined in the "MO Series Symbol List" in Section 2.2 of Publication No. 95.
- Dimensions A, A1 and L are measured with the package seated in JEDEC seating plane gauge GS-3.
- D, D1, and E1 dimensions do not include mold flash or protrusions. Mold flash or protrusions shall not exceed 0.010 inch (0.25mm).
- E and e<sub>A</sub> are measured with the leads constrained to be perpendicular to datum -C-.
- e<sub>B</sub> and e<sub>C</sub> are measured at the lead tips with the leads unconstrained. e<sub>C</sub> must be zero or greater.
- B1 maximum dimensions do not include dambar protrusions. Dambar protrusions shall not exceed 0.010 inch (0.25mm).
- N is the maximum number of terminal positions.
- Corner leads (1, N, N/2 and N/2 + 1) for E8.3, E16.3, E18.3, E28.3, E42.6 will have a B1 dimension of 0.030 - 0.045 inch (0.76 - 1.14mm).

### E8.3 (JEDEC MS-001-BA ISSUE D)

#### 8 LEAD DUAL-IN-LINE PLASTIC PACKAGE

SYMBOL	INCHES		MILLIMETERS		NOTES
	MIN	MAX	MIN	MAX	
A	-	0.210	-	5.33	4
A1	0.015	-	0.39	-	4
A2	0.115	0.195	2.93	4.95	-
B	0.014	0.022	0.356	0.558	-
B1	0.045	0.070	1.15	1.77	8, 10
C	0.008	0.014	0.204	0.355	-
D	0.355	0.400	9.01	10.16	5
D1	0.005	-	0.13	-	5
E	0.300	0.325	7.62	8.25	6
E1	0.240	0.280	6.10	7.11	5
e	0.100 BSC		2.54 BSC		-
e <sub>A</sub>	0.300 BSC		7.62 BSC		6
e <sub>B</sub>	-	0.430	-	10.92	7
L	0.115	0.150	2.93	3.81	4
N	8		8		9

# TVS Diode Arrays

Electronic Protection Array for ESD and Overvoltage Protection

## SP723

### Small Outline Plastic Packages (SOIC)

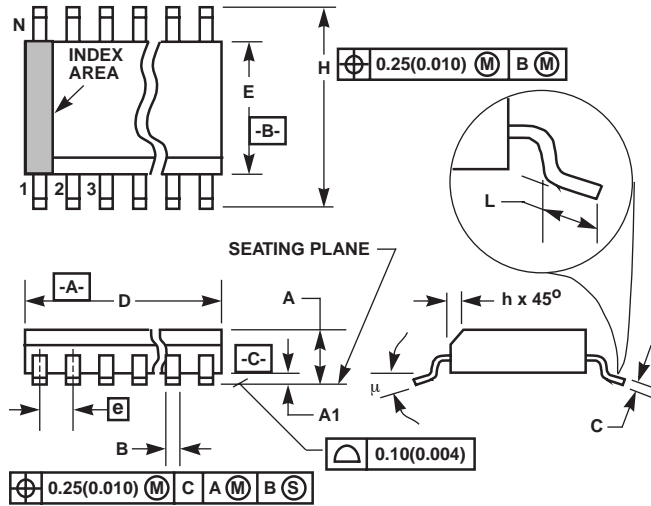

**NOTES:**

- Symbols are defined in the "MO Series Symbol List" in Section 2.2 of Publication Number 95.
- Dimensioning and tolerancing per ANSI Y14.5M-1982.
- Dimension "D" does not include mold flash, protrusions or gate burrs. Mold flash, protrusion and gate burrs shall not exceed 0.15mm (0.006 inch) per side.
- Dimension "E" does not include interlead flash or protrusions. Interlead flash and protrusions shall not exceed 0.25mm (0.010 inch) per side.
- The chamfer on the body is optional. If it is not present, a visual index feature must be located within the crosshatched area.
- "L" is the length of terminal for soldering to a substrate.
- "N" is the number of terminal positions.
- Terminal numbers are shown for reference only.
- The lead width "B", as measured 0.36mm (0.014 inch) or greater above the seating plane, shall not exceed a maximum value of 0.61mm (0.024 inch).
- Controlling dimension: MILLIMETER. Converted inch dimensions are not necessarily exact.

### M8.15 (JEDEC MS-012-AA ISSUE C)

#### 8 LEAD NARROW BODY SMALL OUTLINE PLASTIC PACKAGE

SYMBOL	INCHES		MILLIMETERS		NOTES
	MIN	MAX	MIN	MAX	
A	0.0532	0.0688	1.35	1.75	-
A1	0.0040	0.0098	0.10	0.25	-
B	0.013	0.020	0.33	0.51	9
C	0.0075	0.0098	0.19	0.25	-
D	0.1890	0.1968	4.80	5.00	3
E	0.1497	0.1574	3.80	4.00	4
e	0.050 BSC		1.27 BSC		-
H	0.2284	0.2440	5.80	6.20	-
h	0.0099	0.0196	0.25	0.50	5
L	0.016	0.050	0.40	1.27	6
N	8		8		7
μ	0°	8°	0°	8°	-