

100mA / 50V Digital transistors (with built-in resistors)

DTC143XM / DTC143XE / DTC143XUA / DTC143XKA / DTC143XSA

●Applications

Inverter, Interface, Driver

●Features

- 1) Built-in bias resistors enable the configuration of an inverter circuit without connecting external input resistors (see the equivalent circuit).
- 2) The bias resistors consist of thin-film resistors with complete isolation to allow negative biasing of the input. They also have the advantage of almost completely eliminating parasitic effects.
- 3) Only the on/off conditions need to be set for operation, making the device design easy.

●Structure

NPN epitaxial planar silicon transistor (Resistor built-in type)

●External dimensions (Unit : mm)

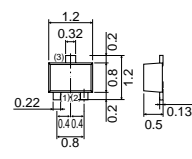
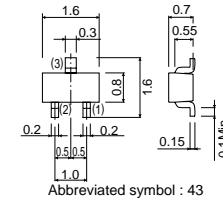
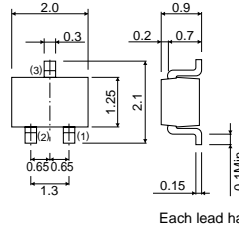
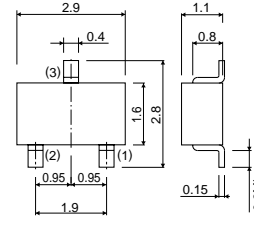
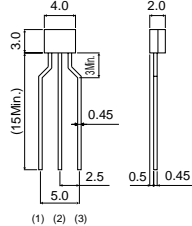
<p>DTC143XM</p>  <p>ROHM : VMT3</p> <p>Abbreviated symbol : 43</p> <p>(1) IN (2) GND (3) OUT</p>	<p>DTC143XE</p>  <p>ROHM : EMT3</p> <p>Abbreviated symbol : 43</p> <p>(1) GND (2) IN (3) OUT</p>
<p>DTC143XUA</p>  <p>ROHM : UMT3 EIAJ : SC-70</p> <p>Each lead has same dimensions</p> <p>Abbreviated symbol : 43</p> <p>(1) GND (2) IN (3) OUT</p>	<p>DTC143XKA</p>  <p>ROHM : SMT3 EIAJ : SC-59</p> <p>Each lead has same dimensions</p> <p>Abbreviated symbol : 43</p> <p>(1) GND (2) IN (3) OUT</p>
<p>DTC143XSA</p>  <p>ROHM : SPT EIAJ : SC-72</p> <p>Abbreviated symbol : C143XS</p> <p>(1) GND (2) OUT (3) IN</p>	

DTC143XM / DTC143XE / DTC143XUA DTC143XKA / DTC143XSA

Transistors

●Packaging specifications

Part No.	Package	VMT3	EMT3	UMT3	SMT3	SPT
	Packaging type	Taping	Taping	Taping	Taping	Taping
	Code	T2L	TL	T106	T146	TP
	Basic ordering unit (pieces)	8000	3000	3000	3000	5000
DTC143XM	○	–	–	–	–	
DTC143XE	–	○	–	–	–	
DTC143XUA	–	–	○	–	–	
DTC143XKA	–	–	–	○	–	
DTC143XSA	–	–	–	–	○	

●Equivalent circuit

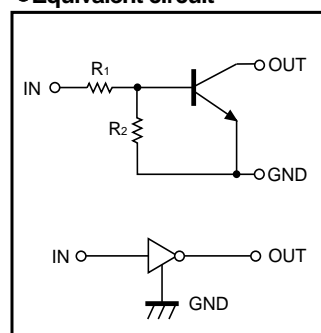

$R_1=4.7k\Omega$, $R_2=10k\Omega$

●Absolute maximum ratings (Ta=25°C)

Parameter	Symbol	Limits					Unit
		DTC143XM	DTC143XE	DTC143XUA	DTC143XKA	DTC143XSA	
Supply voltage	V_{CC}	50					V
Input voltage	V_{IN}	-7 to +20					V
Output current	I_o	100					mA
	$I_{C(Max)}$	100					
Power dissipation	P_D	150		200		300	mW
Junction temperature	T_j	150					°C
Storage temperature	T_{stg}	-55 to +150					°C

●Electrical characteristics (Ta=25°C)

Parameter	Symbol	Min.	Typ.	Max.	Unit	Conditions
Input voltage	$V_{I(off)}$	–	–	0.3	V	$V_{CC}=5V$, $I_o=100\mu A$
	$V_{I(on)}$	2.5	–	–		$V_o=0.3V$, $I_o=20mA$
Output voltage	$V_{O(on)}$	–	0.1	0.3	V	$I_o/I_i=10mA/0.5mA$
Input current	I_i	–	–	1.8	mA	$V_i=5V$
Output current	$I_{O(off)}$	–	–	0.5	μA	$V_{CC}=50V$, $V_i=0V$
DC current gain	G_i	30	–	–	–	$V_o=5V$, $I_o=10mA$
Input resistance	R_1	3.29	4.7	6.11	$k\Omega$	–
Resistance ratio	R_2/R_1	1.7	2.1	2.6	–	–
Transition frequency	f_T *	–	250	–	MHz	$V_{CE}=10V$, $I_E=-5mA$, $f=100MHz$

* Characteristics of built-in transistor

Transistors

●Electrical characteristic curves

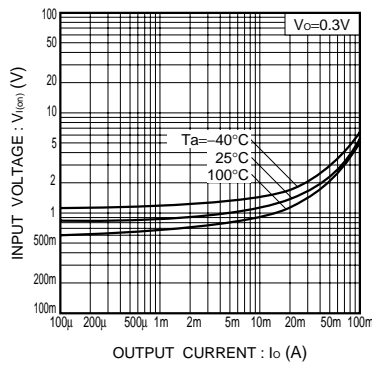

Fig.1 Input voltage vs. output current (ON characteristics)

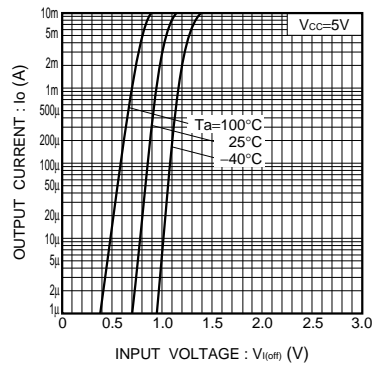

Fig.2 Output current vs. input voltage (OFF characteristics)

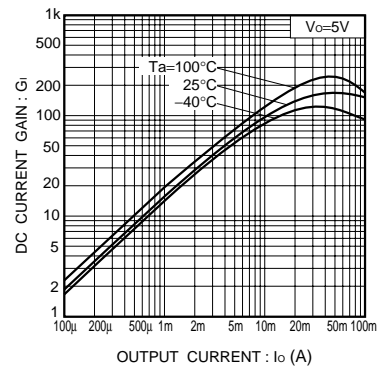

Fig.3 DC current gain vs. output current

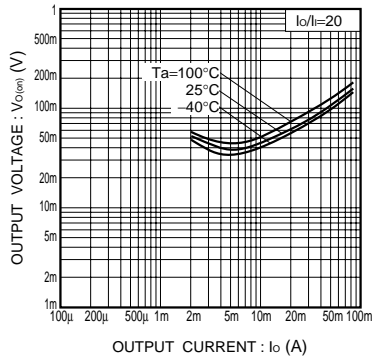

Fig.4 Output voltage vs. output current

Notes

- No technical content pages of this document may be reproduced in any form or transmitted by any means without prior permission of ROHM CO.,LTD.
- The contents described herein are subject to change without notice. The specifications for the product described in this document are for reference only. Upon actual use, therefore, please request that specifications to be separately delivered.
- Application circuit diagrams and circuit constants contained herein are shown as examples of standard use and operation. Please pay careful attention to the peripheral conditions when designing circuits and deciding upon circuit constants in the set.
- Any data, including, but not limited to application circuit diagrams information, described herein are intended only as illustrations of such devices and not as the specifications for such devices. ROHM CO.,LTD. disclaims any warranty that any use of such devices shall be free from infringement of any third party's intellectual property rights or other proprietary rights, and further, assumes no liability of whatsoever nature in the event of any such infringement, or arising from or connected with or related to the use of such devices.
- Upon the sale of any such devices, other than for buyer's right to use such devices itself, resell or otherwise dispose of the same, no express or implied right or license to practice or commercially exploit any intellectual property rights or other proprietary rights owned or controlled by
- ROHM CO., LTD. is granted to any such buyer.
- Products listed in this document are no antiradiation design.

The products listed in this document are designed to be used with ordinary electronic equipment or devices (such as audio visual equipment, office-automation equipment, communications devices, electrical appliances and electronic toys).

Should you intend to use these products with equipment or devices which require an extremely high level of reliability and the malfunction of which would directly endanger human life (such as medical instruments, transportation equipment, aerospace machinery, nuclear-reactor controllers, fuel controllers and other safety devices), please be sure to consult with our sales representative in advance.

About Export Control Order in Japan

Products described herein are the objects of controlled goods in Annex 1 (Item 16) of Export Trade Control Order in Japan.

In case of export from Japan, please confirm if it applies to "objective" criteria or an "informed" (by MITI clause) on the basis of "catch all controls for Non-Proliferation of Weapons of Mass Destruction.