

DESCRIPTION

The MP5077 provides up to 7A load protection over a 0.5V to 5.5V voltage range. With the small $R_{DS(ON)}$ in tiny package, MP5077 is a very high efficiency and space saving solution for notebooks, tablets, and other portable/battery-operated applications.

With the soft start function, the MP5077 can avoid inrush current during circuit start up. MP5077 also provides programmable soft start time, output discharge functions, OCP and thermal shutdown features.

The maximum load at the output (source) is current limited. This is accomplished by utilizing a sense FET topology. The magnitude of the current limit is controlled by an external resistor from the ILIM pin to ground.

An internal charge pump drives the gate of the power device, allowing a very low on-resistance DMOS power FET of just 10m Ω .

The MP5077 is available in a tiny 12-pin 2mmx2mm QFN package.

FEATURES

- Integrated 10m Ω Low $R_{DS(ON)}$ FETs
- Adjustable Start Up Slew Rate
- Wide V_{IN} Range from 0.5V to 5.5V
- <1 μ A Shutdown Current
- Programmable 7A Current Limit Range
- Output Discharge Function
- Enable Pin
- <200ns Short-Circuit Protection Response Time
- Thermal Protection
- Small 2mmx2mm QFN Package for Space Saving

APPLICATIONS

- Notebook and Tablet Computers
- Portable Devices
- Solid State Drives
- Handheld Devices

All MPS parts are lead-free and adhere to the RoHS directive. For MPS green status, please visit MPS website under Products, Quality Assurance page. "MPS" and "The Future of Analog IC Technology" are registered trademarks of Monolithic Power Systems, Inc.

TYPICAL APPLICATION

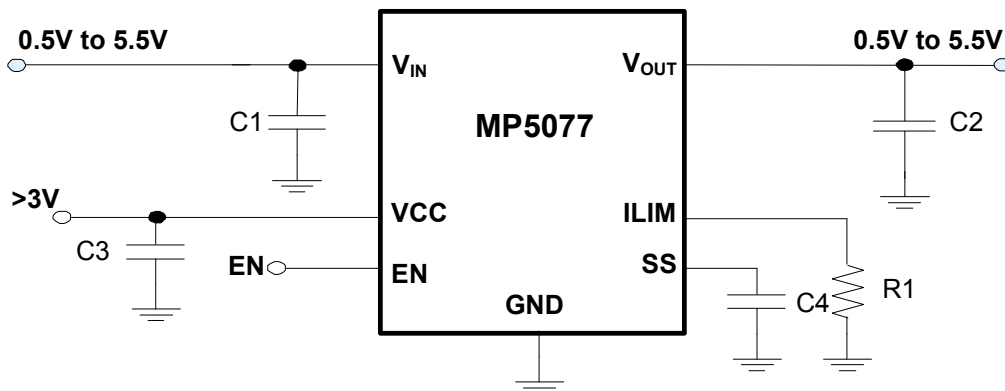

ORDERING INFORMATION

| Part Number* | Package | Top Marking |
|--------------|------------------|-------------|
| MP5077GG | QFN-12 (2mmx2mm) | See Blow |

* For Tape & Reel, add suffix -Z (e.g. MP5077GG-Z);

TOP MARKING

—
CCY
LLL

CC: product code of MP5077GG;
Y: year code;
LLL: lot number;

PACKAGE REFERENCE

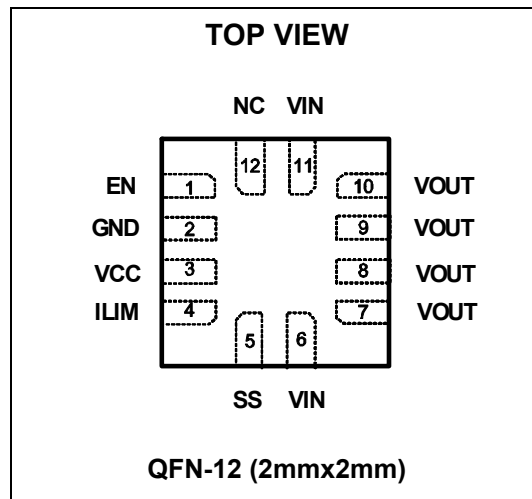

ABSOLUTE MAXIMUM RATINGS ⁽¹⁾

| | |
|---|---------------------------------|
| V _{IN} | -0.3V to +6.5V |
| V _{CC} | -0.3V to +6.5V |
| V _{OUT} | -0.3V to +6.5V |
| EN, SS, ILIM..... | -0.3V to V _{CC} +0.3 V |
| Junction Temperature..... | 150°C |
| Lead Temperature..... | 260°C |
| Continuous Power Dissipation ⁽²⁾ | |
| QFN-12 (2mmx2mm)..... | 1.6W |

Recommended Operating Conditions ⁽³⁾

| | |
|---------------------------------------|-----------------|
| Supply Voltage V _{IN} | 0.5V to 5.5V |
| Supply Voltage V _{CC} | 3V to 5.5V |
| Output Voltage V _{OUT} | 0.5V to 5.5V |
| Operating Junction Temp..... | -40°C to +125°C |

| | | | |
|--|-----------------------|-----------------------|------|
| Thermal Resistance ⁽⁴⁾ | θ_{JA} | θ_{JC} | |
| QFN-12 (2mmx2mm) | 80 | 16 | °C/W |

Notes:

- 1) Exceeding these ratings may damage the device.
- 2) The maximum allowable power dissipation is a function of the maximum junction temperature T_J (MAX), the junction-to-ambient thermal resistance θ_{JA}, and the ambient temperature T_A. The maximum allowable continuous power dissipation at any ambient temperature is calculated by P_D (MAX) = (T_J (MAX)-T_A)/θ_{JA}. Exceeding the maximum allowable power dissipation will cause excessive die temperature, and the regulator will go into thermal shutdown. Internal thermal shutdown circuitry protects the device from permanent damage.
- 3) The device is not guaranteed to function outside of its operating conditions.
- 4) Measured on JESD51-7, 4-layer PCB.

ELECTRICAL CHARACTERISTICS

$V_{IN} = 3.6V$, $V_{CC} = 3.6V$, $T_A = 25^{\circ}C$, unless otherwise noted.

| Parameters | Symbol | Condition | Min | Typ | Max | Units |
|--|----------------|---|------|------|------|-------------|
| Input and Supply Voltage Range | | | | | | |
| Input Voltage | V_{IN} | | 0.5 | | 5.5 | V |
| Supply Voltage | V_{CC} | | 3 | | 5.5 | V |
| Supply Current | | | | | | |
| Off State Leakage Current | I_{OFF} | $V_{IN}=5V$, $EN=0$ | | | 1 | μA |
| V_{CC} Standby Current | I_{STBY} | $V_{CC}=5V$, $EN=0$ | | 0.1 | 1 | μA |
| | | $V_{CC}=5V$, Enable, No load | | 220 | 330 | |
| Power FET | | | | | | |
| ON Resistance | R_{DSON} | $V_{CC}=5.0V$ | | 10 | | m Ω |
| | | $V_{CC}=3.3V$ | | 12 | | |
| Thermal Shutdown and Recovery | | | | | | |
| Shutdown Temperature ⁽⁵⁾ | T_{STD} | | | 155 | | $^{\circ}C$ |
| Hysteresis ⁽⁵⁾ | T_{HYS} | | | 30 | | $^{\circ}C$ |
| Under Voltage Protection | | | | | | |
| V_{CC} Under Voltage Lockout Threshold | V_{CC_UVLO} | UVLO Rising Threshold | | 2.6 | 2.8 | V |
| UVLO Hysteresis | $V_{UVLOHYS}$ | | | 200 | | mV |
| Soft Start | | | | | | |
| SS pull-up current | I_{SS} | | | 9 | | μA |
| Enable | | | | | | |
| EN Rising Threshold | V_{ENH} | | 1.3 | 1.5 | 1.7 | V |
| EN Hysteresis | V_{EN_HYS} | | | 400 | | mV |
| Current Limit | | | | | | |
| Current limit | I_{OUT} | $R_{LIMIT}=50k\Omega$, ramp lout record peak current limit | 1.54 | 1.64 | 1.74 | A |
| Discharge Resistance | | | | | | |
| Discharge Resistance | R_{DIS} | | | 200 | | Ω |

Notes:

5) Guarantee by Characterization-Not Production tested.

PIN FUNCTIONS

| Pin # | Name | Description |
|-------------|------|---|
| 1 | EN | Enable Input. Pulling this pin below the specified threshold shuts the chip down. |
| 2 | GND | Ground. |
| 3 | VCC | Supply Voltage to the Control Circuitry. |
| 4 | ILIM | Output Current Limit Configure. Place a resistor to ground to set the overload current limit level. |
| 5 | SS | Soft start pin. An external capacitor connected to this pin sets the slew rate of the output voltage soft start period. |
| 6, 11 | VIN | Input Power Supply. |
| 7, 8, 9, 10 | VOUT | Output to the load. |
| 12 | NC | Factory Test Pin. Keep it floating. |

TYPICAL PERFORMANCE CHARACTERISTICS

$V_{IN} = 3.6V$, $V_{CC} = 3.6V$, $EN=2.5V$, $R_{LIM} = 10.5k$, $T_A = 25^\circ C$, unless otherwise noted.

Vcc Standby Current vs. Vcc

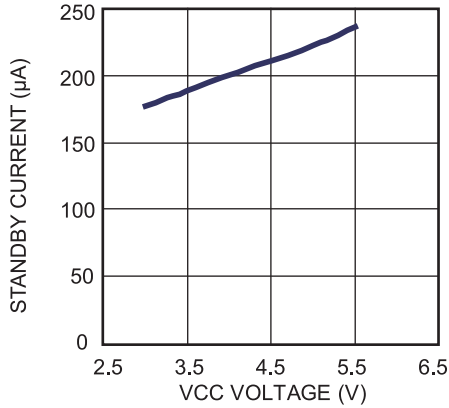

Vcc Standby Current vs. Temperature

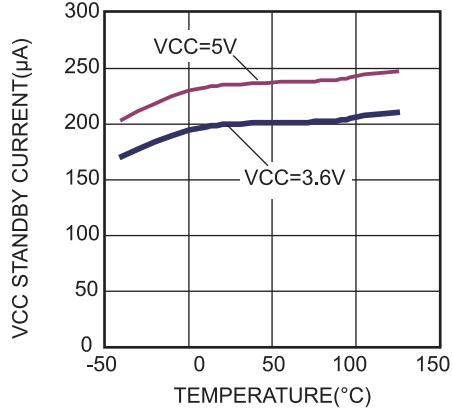

Disabled Supply Current vs. Input Voltage

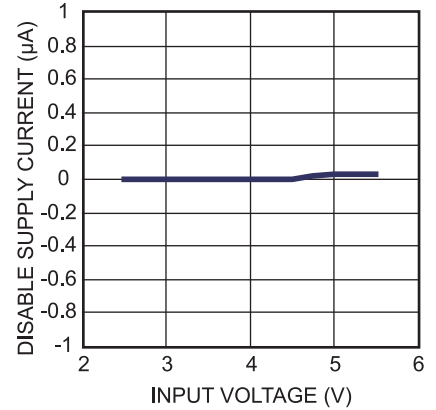

VIN UVLO Rising Threshold vs. Temperature

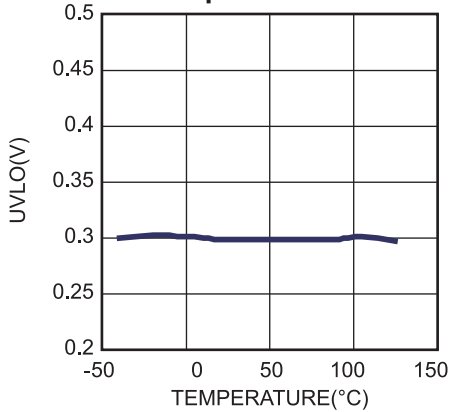

EN Rising Threshold vs. Temperature

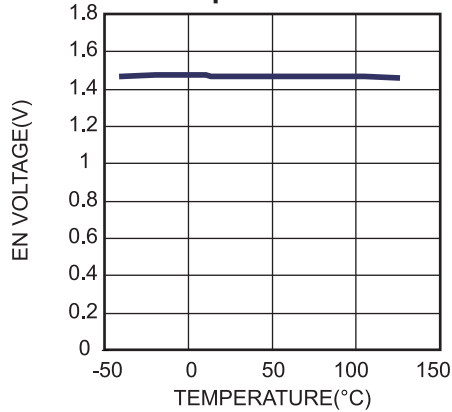

EN Falling Threshold vs. Temperature

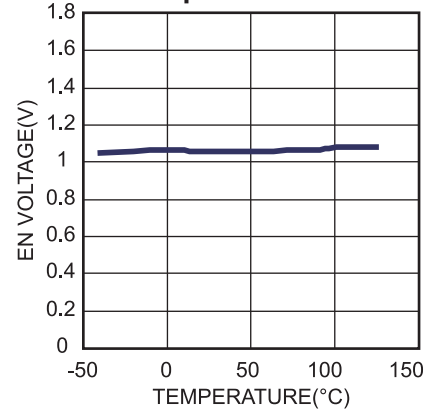

Rds_on vs. Vcc

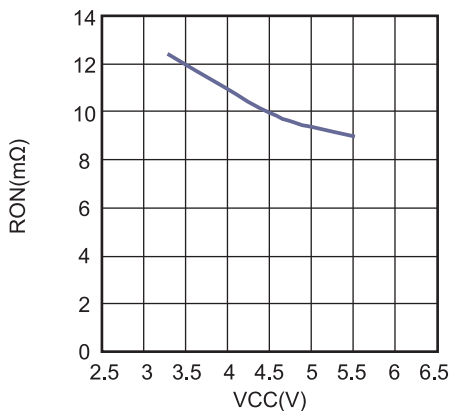

Rds_on vs. Temperature

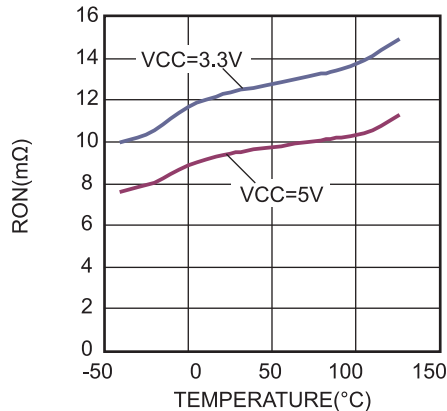

Current Limit vs Rlimit

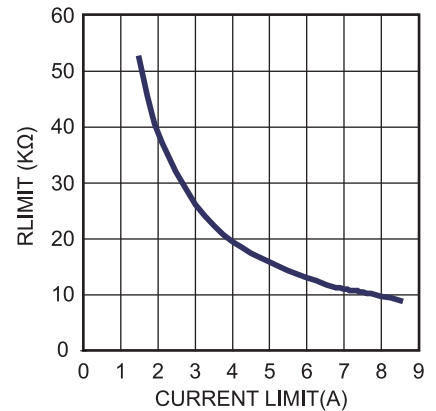

TYPICAL PERFORMANCE CHARACTERISTICS (continued)

$V_{IN} = 3.6V$, $V_{CC} = 3.6V$, $EN=2.5V$, $R_{LIM} = 10.5k$, $T_A = 25^\circ C$, unless otherwise noted.

I_{LIMIT} vs. Temperature

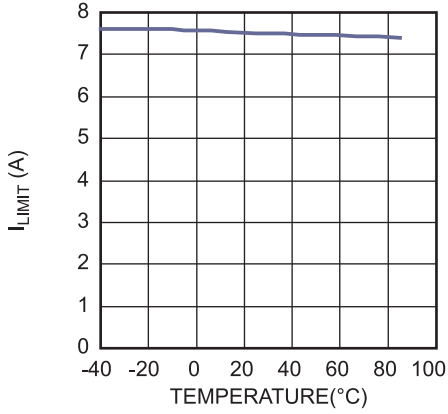

Soft-Start vs. Cap

$V_{IN}=5V$, $V_{CC}=3.6V$

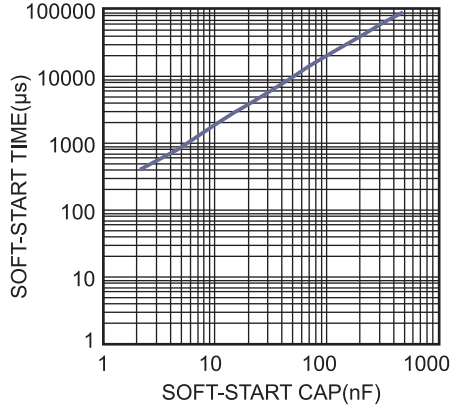

Case Temperature Rise vs. Output Current

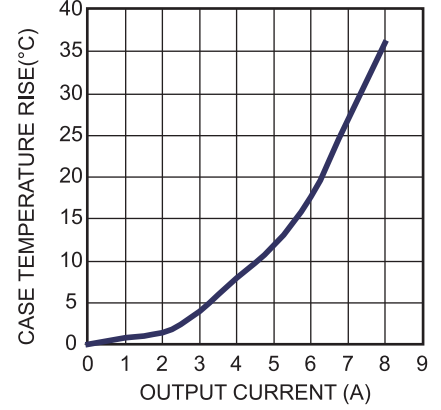

TYPICAL PERFORMANCE CHARACTERISTICS (continued)

$V_{IN} = 3.6V$, $V_{CC} = 3.6V$, $EN=2.5V$, $R_{LIM} = 10.5k$, $T_A = 25^\circ C$, unless otherwise noted.

Enable Startup

$V_{IN} = 3.6V$, $V_{CC} = 3.6V$, No Load

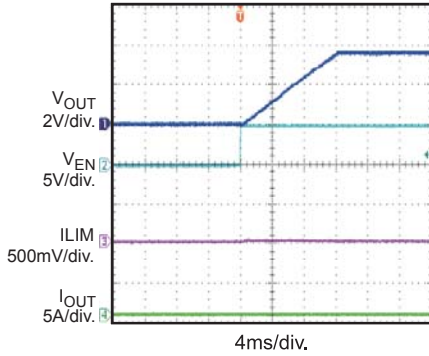

Enable Startup

$V_{IN} = 3.6V$, $V_{CC} = 3.6V$, 7A Load

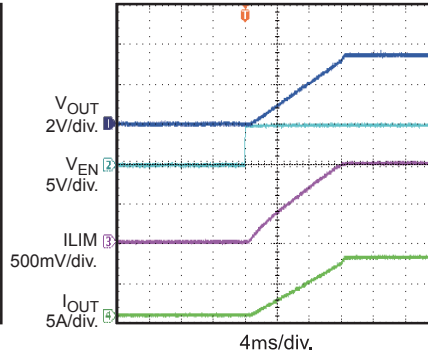

Enable Shutdown

$V_{IN} = 3.6V$, $V_{CC} = 3.6V$, No Load

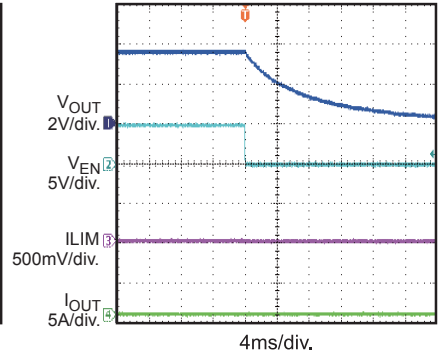

Enable Shutdown

$V_{IN} = 3.6V$, $V_{CC} = 3.6V$, 7A Load

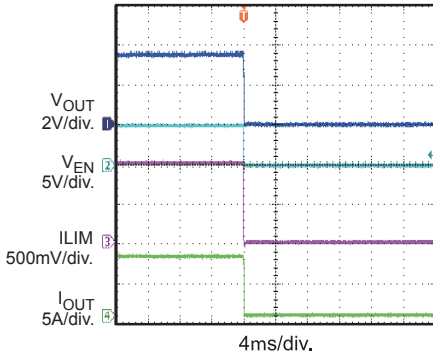

Power Up

$V_{IN} = 3.6V$, $V_{CC} = 3.6V$, No Load

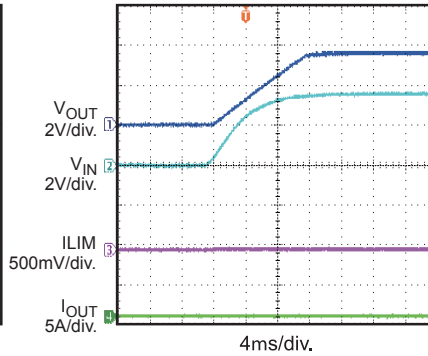

Power Up

$V_{IN} = 3.6V$, $V_{CC} = 3.6V$, 7A Load

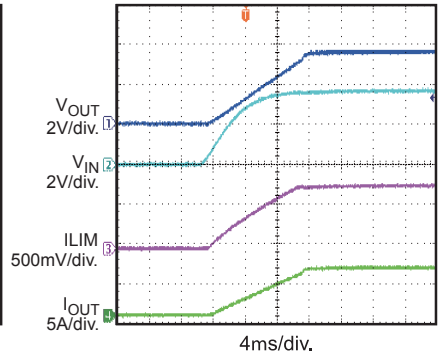

Power Down

$V_{IN} = 3.6V$, $V_{CC} = 3.6V$, No Load

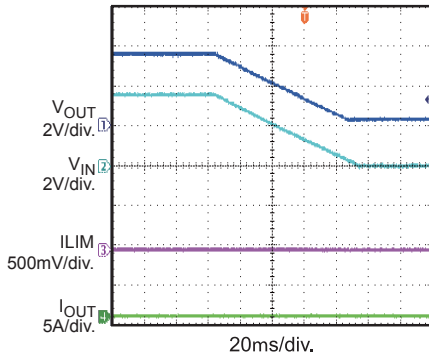

Steady State

$V_{IN} = 3.6V$, $V_{CC} = 3.6V$, 7A Load

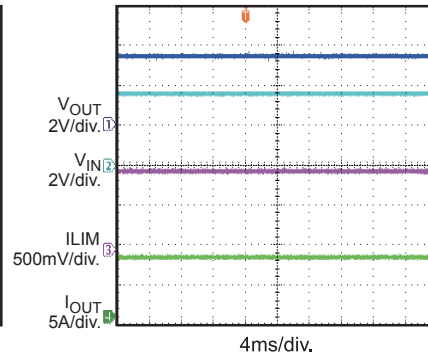

Load Transient Response

$V_{IN} = 5V$, $V_{CC} = 3.3V$, $I_{OUT} = 0A-7A$

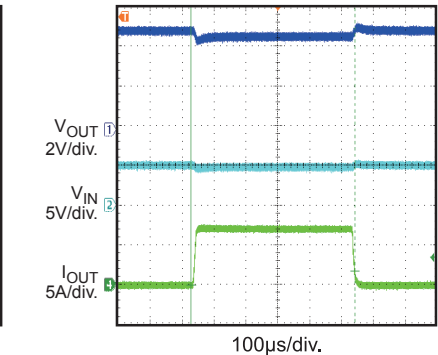

TYPICAL PERFORMANCE CHARACTERISTICS (continued)

$V_{IN} = 3.6V$, $V_{CC} = 3.6V$, $EN=2.5V$, $R_{LIM} = 10.5k$, $T_A = 25^\circ C$, unless otherwise noted.

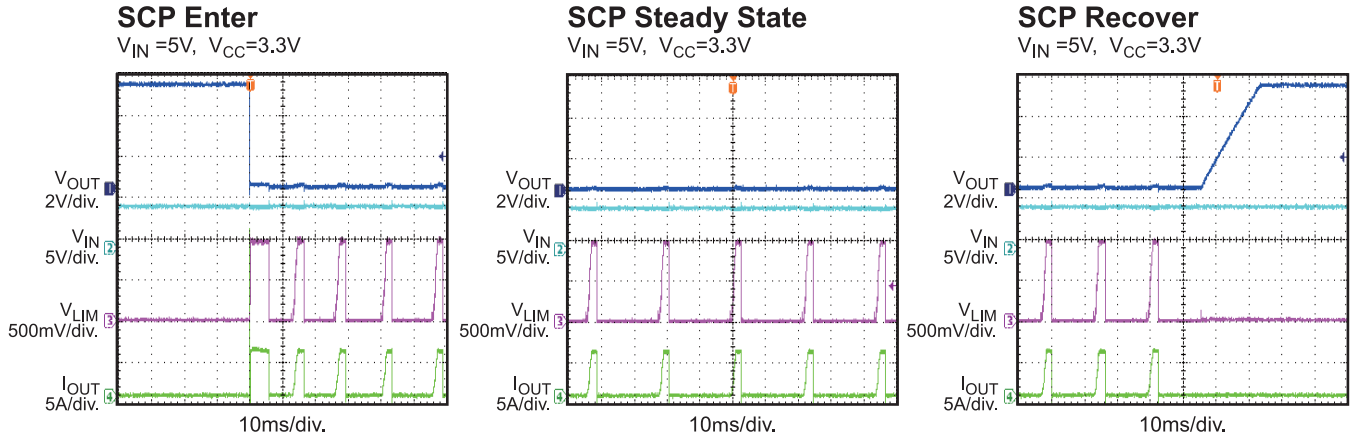

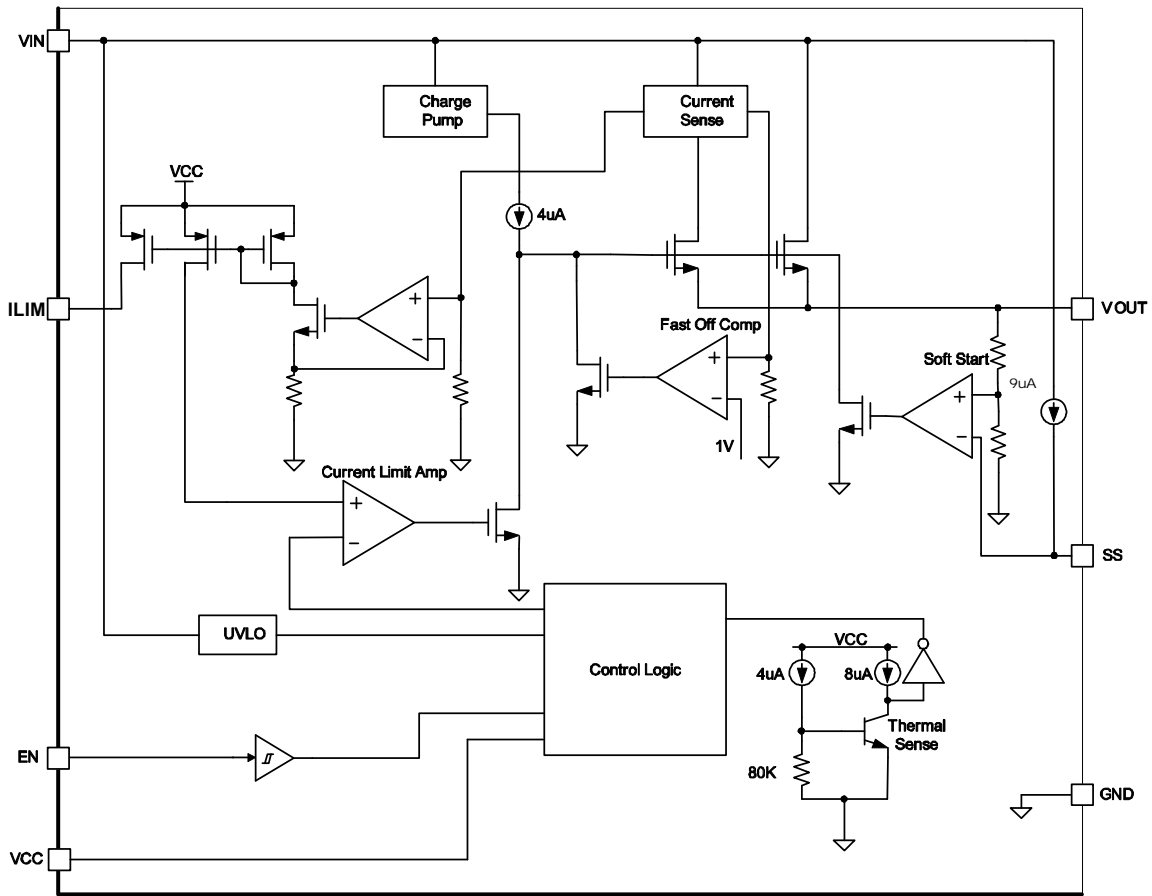

Figure 1: Functional Block Diagram

OPERATION

The MP5077 is designed to limit the in-rush current to the load thereby limiting the backplane's voltage drop and the slew rate of the voltage to the load. It provides an integrated solution to monitor the input voltage, output voltage and output current to eliminate the need for an external current power MOSFET, and current switch device.

Enable

When input voltage is greater than the under-voltage lockout threshold (UVLO), typically 0.5V, MP5077 can be enabled by pulling EN pin to higher than 1.5V. Pulling down to ground or floating will disable MP5077.

Current Limit

The MP5077 provides a constant current limit that can be programmed by an external resistor. Once the device reaches its current limit threshold, the internal circuit regulates the gate voltage to hold the current in the power FET constant. The typical response time is about 20µs and the output current may have a small overshoot during this time period.

The pre-set current limit value can be calculated by below equation:

$$I_{Limit} = (1 \div R_{Limit}) \times S \quad (1)$$

S is the current sense ratio of MP5077, and this value is typically 82000 in $V_{IN}=3.6V$. The other values of S please refer the curves in typical performance characteristics.

If the current limit block starts to regulate the output current, the power loss on power MOSFET will cause the IC temperature rise. If the junction temperature rose to high enough, it will trigger thermal shutdown. After thermal shutdown happened, it will disable the output until the over temperature fault remove. The over temperature threshold is 155°C and hysteresis is 30°C.

Short-Circuit Protection

If the load current increases rapidly due to a short circuit, the current may exceed the current limit threshold by a lot before the control loop can respond. If the current reaches an internal secondary current limit level (typical 13A), a fast turn-off circuit activates to turn off the power FET. This limits the peak current through the switch to limit the input voltage drop. The total short circuit response time is about 200ns. If fast off works, it will keep off the power FET for 80µs. After that time period, it will re-turn on power FET. If the part is still in short-circuit condition. MP5077 will reduce the current limit to 2/3 of pre-set value, and hold it until the part is so hot and thermal shutdown. After the short-circuit condition removed, the current limit will recover to the pre-set value automatically.

Output Discharge

MP5077 has output discharge function. This function can discharge the V_o by internal pull down resistance when IC EN disabled or V_{CC} shutdown and the load is very light.

Soft-Start

A capacitor connected to the SS pin determines the soft-start time. There is an internal 9µA constant current source charge SS cap and ramps up the voltage on the SS pin. The output voltage rises at 3 times the slew rate to SS voltage.

The soft-start time can be calculated by below equation:

$$T_{SS}(\text{ms}) = \frac{1}{3} \times \frac{V_{OUT}(\text{V}) \cdot C_{SS}(\text{nF})}{I_{SS}(\text{uA})} \quad (2)$$

T_{SS} is the soft-start time, I_{SS} is internal 9µA constant current, C_{SS} is external soft-start cap.

The suggestion minimum SS cap should be bigger than 4.7nF. If the SS pin is floated or SS cap is too small, the V_{out} rising time will be just limited by power MOS charge time.

APPLICATION INFORMATION

ILIM Resistor Selection

The current limit value can be set by ILIM resistor. The current limit can be gotten by equation (1).

The current limit threshold is suggested to 10% ~ 20% higher than maximum load current. For example, if the system's full load is 7A, set the current limit to 7.7A.

Soft Start Capacitor Selection

There is an internal 9μA constant current source charge SS cap and ramps up the voltage on the SS pin. The output voltage rises follow 3 times the slew rate of SS voltage.

If the inrush on output current reached the current limit during start up (like with large output cap or very large load), MP5077 will limit the output current and the same time, SS time will be increased (Figure 2 and Figure 3).

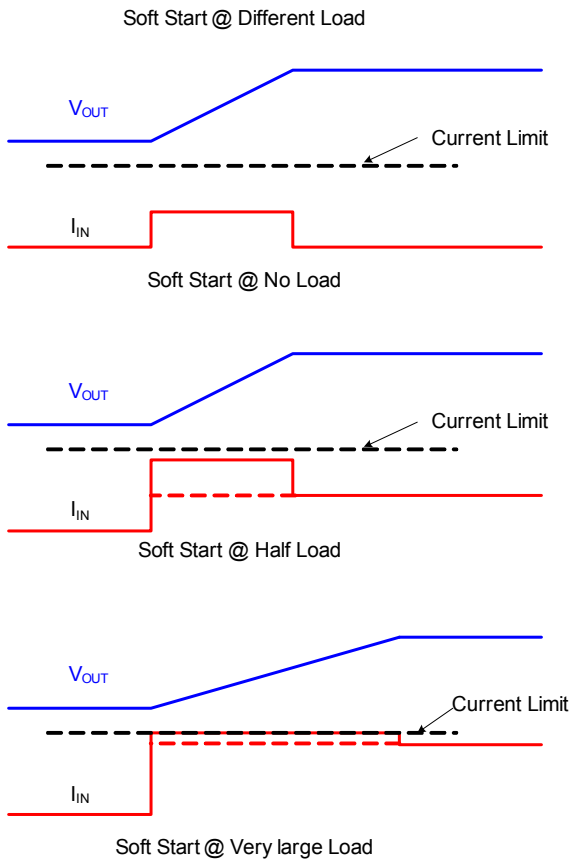

Figure 2: Soft Start Periods at different load

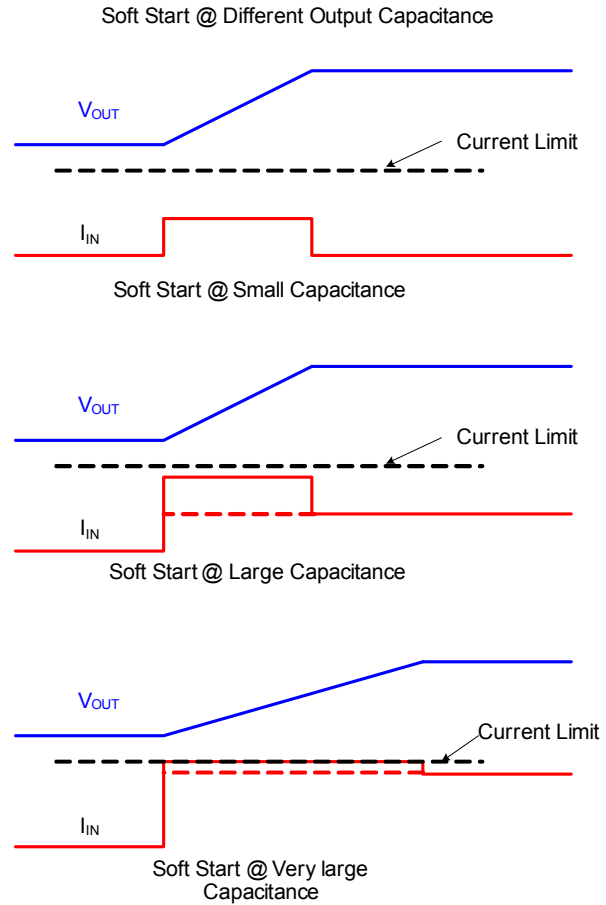

Figure 3: Soft Start Periods at different output capacitance

Design Example

Some design example and are provided below. See Table 1 and Figure 4.

Table 1

| Vin (V) | Max Load Range (A) | Rlimit (kΩ) | SS cap (nF) | SS time (ms) |
|---------|--------------------|-------------|-------------|--------------|
| 5 | 3 | 26.1 | 22 | 4 |
| 5 | 5 | 15.8 | 47 | 9 |
| 5 | 7.5 | 10.5 | 100 | 20 |

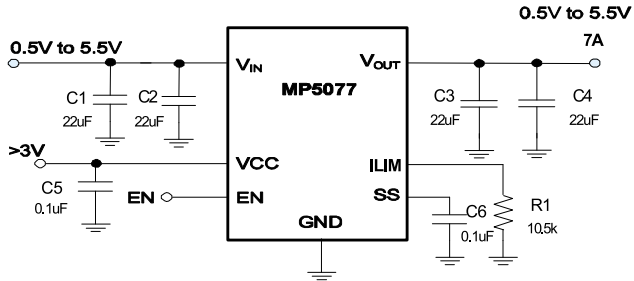

Figure 4: Typical Application Schematic

Layout Guide

PCB layout is very important to achieve stable operation. Please follow these guidelines and take below figure for reference. Place R_{LIMIT} close to ILIM pin, input cap close to V_{CC} pin. Put enough vias around IC to achieve better thermal performance.

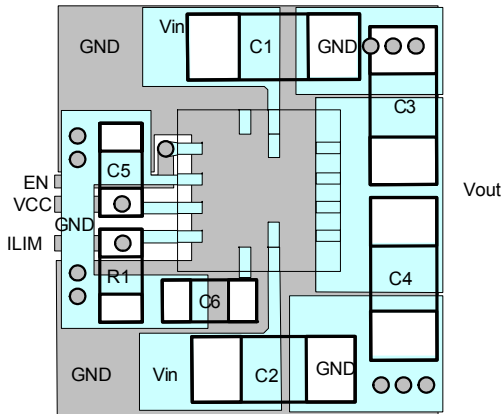
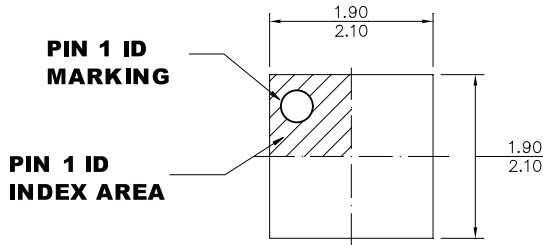

Figure 5: Recommended Layout

PACKAGE INFORMATION

QFN12 (2mmx2mm)



TOP VIEW

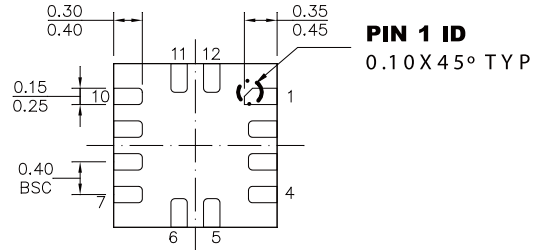

BOTTOM VIEW

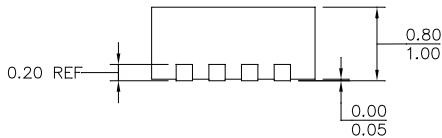

SIDE VIEW

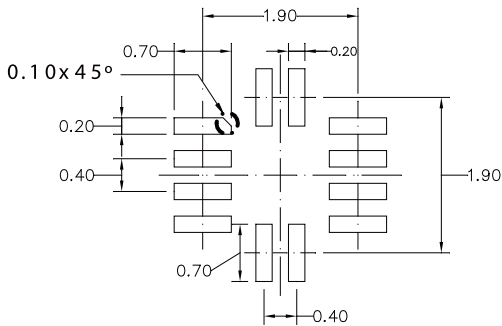

RECOMMENDED LAND PATTERN

NOTE:

- 1) ALL DIMENSIONS ARE IN MILLIMETERS
- 2) EXPOSED PADDLE SIZE DOES NOT INCLUDE MOLD FLASH
- 3) LEAD COPLANARITY SHALL BE 0.10 MILLIMETERS MAX.
- 4) JEDEC REFERENCE IS MQ220.
- 5) DRAWING IS NOT TO SCALE

NOTICE: The information in this document is subject to change without notice. Please contact MPS for current specifications. Users should warrant and guarantee that third party Intellectual Property rights are not infringed upon when integrating MPS products into any application. MPS will not assume any legal responsibility for any said applications.