

Maximum 3A, Ultra Low Dropout Regulator

General Description

The RT9042 is a high performance positive voltage regulator designed for use in applications requiring very low Input voltage and extremely low dropout voltage at up to 3A(Peak). It operates with a VIN as low as 1V and VDD voltage 3V with programmable output voltage as low as 0.8V. The RT9042 features ultra low dropout that is ideal for applications where VOUT is very close to VIN. Additionally, it has an enable pin to further reduce power dissipation while shutdown and provides excellent regulation over variations in line, load and temperature. The RT9042 provides a power good signal to indicate if the voltage level of Vo reaches 90% of its rating value. The RT9042 is available in the SOP-8 and SOP-8 (Exposed Pad) package with 1.05V, 1.2V, 1.5V, 1.8V and 2.5V internally preset outputs that are also adjustable by using external resistors.

Ordering Information

RT9042□□□□

- Package Type
 - S : SOP-8
 - SP : SOP-8 (Exposed Pad-Option 1)
- Lead Plating System
 - G : Green (Halogen Free and Pb Free)
 - Z : ECO (Ecological Element with Halogen Free and Pb free)
- Output Voltage
 - 1K : 1.05V/Adj
 - 12 : 1.2V/Adj
 - 15 : 1.5V/Adj
 - 18 : 1.8V/Adj
 - 25 : 2.5V/Adj

Note :

Richtek products are :

- } RoHS compliant and compatible with the current requirements of IPC/JEDEC J-STD-020.
- } Suitable for use in SnPb or Pb-free soldering processes.

Features

- ▮ Maximum 3A Low Dropout Voltage Regulator
- ▮ High Accuracy Output Voltage 2%
- ▮ Dropout Voltage Typical 230mV at 2A
- ▮ Power Good Output
- ▮ Output Voltage Pull Low Resistance when Disable
- ▮ Thermal and Over Current Protection
- ▮ RoHS Compliant and Halogen Free

Applications

- ▮ Notebook PC Applications
- ▮ Motherboard Applications

Pin Configurations

(TOP VIEW)

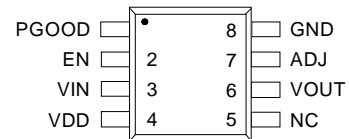

SOP-8

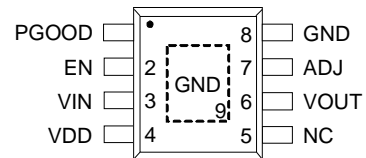

SOP-8 (Exposed Pad)

Typical Application Circuit

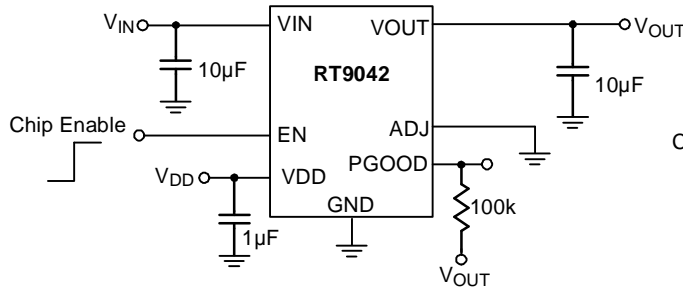

Figure 1. Fixed Voltage Regulator

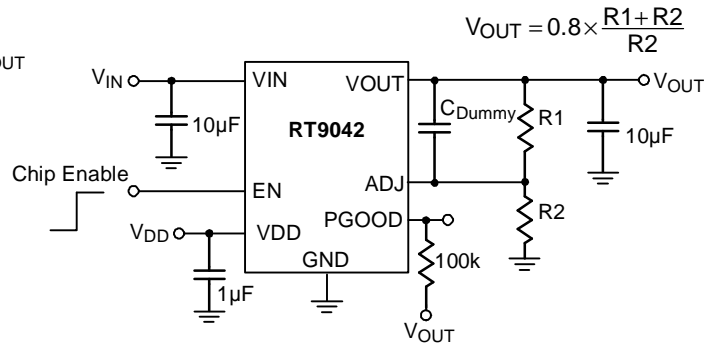
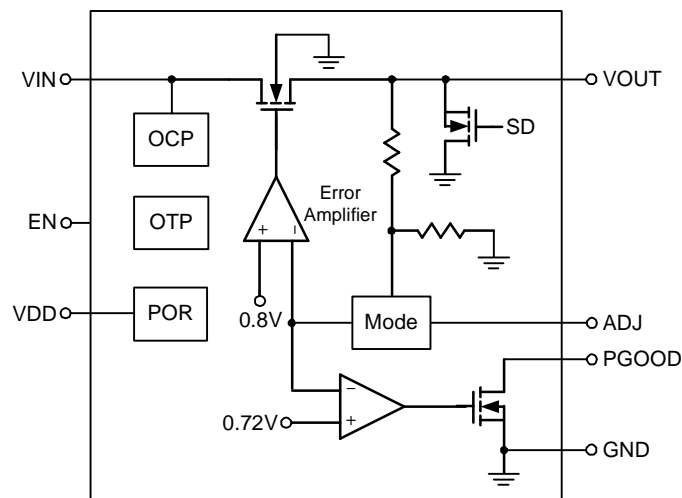

Figure 2. Adjustable Voltage Regulator

Functional Pin Description

Pin No.	Pin Name	Pin Function
1	PGOOD	Power Good Open Drain Output.
2	EN	Chip Enable (Active High).
3	VIN	Supply Input Voltage.
4	VDD	Supply Voltage of Control Circuit.
5	NC	No Internal Connection.
6	VOUT	Output Voltage.
7	ADJ	Set the output voltage by the internal feedback resistors when ADJ is grounded. If external feedback resistors is used, $V_{OUT} = 0.8V \times (R2+R1)/R2$.
8, 9 (Exposed Pad)	GND	Ground. The exposed pad must be soldered to a large PCB and connected to GND for maximum power dissipation.

Function Block Diagram



Absolute Maximum Ratings (Note 1)

Supply Input Voltage, V_{IN} -----	6V
Control Voltage -----	6V
Output Voltage -----	6V
Power Dissipation, P_D @ $T_A = 25^\circ\text{C}$	
SOP-8 -----	0.833W
SOP-8 (Exposed Pad) -----	1.333W
Package Thermal Resistance (Note 2)	
SOP-8, θ_{JA} -----	120°C/W
SOP-8, θ_{JC} -----	60°C/W
SOP-8 (Exposed Pad), θ_{JA} -----	75°C/W
SOP-8 (Exposed Pad), θ_{JC} -----	15°C/W
Lead Temperature (Soldering, 10 sec.) -----	260°C
Junction Temperature -----	150°C
Storage Temperature Range -----	-65°C to 150°C
ESD Susceptibility (Note 3)	
HBM (Human Body Mode) -----	2kV
MM (Machine Mode) -----	200V

Recommended Operating Conditions (Note 4)

Supply Input Voltage, V_{IN} -----	1.4V to 5V
Control Voltage, V_{DD} -----	4.5V to 5.5V
Junction Temperature Range -----	-40°C to 125°C
Ambient Temperature Range -----	-40°C to 85°C

Electrical Characteristics

($V_{IN} = V_{OUT} + 500\text{mV}$, $V_{EN} = V_{DD} = 5\text{V}$, $C_{IN} = C_{OUT} = 10\mu\text{F}$, $T_A = 25^\circ\text{C}$, unless otherwise specified)

Parameter	Symbol	Test Conditions	Min	Typ	Max	Unit
VIN						
Input Voltage Range	V_{IN}		1.4	--	5	V
Quiescent Current (GND Current) (Note 5)	I_Q	$V_{DD} = 5\text{V}$	--	0.6	1.2	mA
VDD						
VDD Operation Range	V_{DD}	V_{DD} Input Range	4.5	--	5.5	V
VOUT						
Fixed Output Voltage		$V_{DD} = 5\text{V}$	-2	0	2	%
V_{OUT} Load Regulation (Note 6)	ΔV_{LOAD}	$V_{DD} = 5\text{V}$, $I_{OUT} = 2\text{A}$, $V_{IN} = V_{OUT} + 1\text{V}$	--	0.2	1	%
V_{OUT} Line Regulation (V_{IN})	ΔV_{LINE_IN}	$V_{DD} = 5\text{V}$, $V_{IN} = V_{OUT} + 1\text{V}$ to 5V $I_{OUT} = 1\text{mA}$	--	0.2	0.6	%
Dropout Voltage (Note 7)	V_{DROP}	$V_{DD} = 5\text{V}$, $I_{OUT} = 2\text{A}$	--	230	300	mV

To be Continued

Parameter	Symbol	Test Conditions	Min	Typ	Max	Unit	
Current Limit	I_{LIM}	$V_{DD} = 5V, V_{IN} = 3.6V$	3.1	--	--	A	
Short Circuit Current		$V_{DD} = 5V, V_{OUT} < 0.2V$	--	1.8	--	A	
In-rush Current		$V_{DD} = 5V, C_{OUT} = 10\mu F, \text{Enable Start-up}, I_{LOAD} = 1A$	--	0.5	--	A	
V_{OUT} Pull Low Resistance		$V_{EN} = 0V$	--	150	--	Ω	
V_{OUT} Rising Time		10% to 90%, $V_{OUT} = 1.8V$	--	200	600	μs	
ADJ							
Reference Voltage (ADJ)	V_{ADJ}	$V_{DD} = 5V, V_{OUT} = 2.5V$	0.788	0.8	0.812	V	
ADJ Pin Threshold			--	0.2	--	V	
Power-On Reset							
POR Threshold			2.4	2.7	3	V	
POR Falling Hysteresis			0.15	0.2	--	V	
Power Good							
Power Good Rising Threshold		$V_{DD} = 5V$	--	90	--	%	
Power Good Hysteresis		$V_{DD} = 5V$	--	10	--	%	
Power Good Sink Capability		$V_{DD} = 5V, I_{OUT} = 10mA$	--	0.2	0.4	V	
Chip Enable							
EN Threshold Voltage	Logic-High	V_{EN_H}	$V_{DD} = 5V$	1.2	--	--	V
	Logic-Low	V_{EN_L}	$V_{DD} = 5V$	--	--	0.6	
EN Pin Bias Current		I_{EN}	$V_{EN} = 5V$	--	12	--	μA
V_{DD} Shutdown Current		I_{SHDN}	$V_{DD} = 5V, V_{EN} = 0V$	--	--	1	μA
Over Temperature Protection							
Thermal Shutdown Temperature		T_{SD}	--	160	--	$^{\circ}C$	
Thermal Shutdown Returned Temperature			--	90	--	$^{\circ}C$	

Note 1. Stresses listed as the above "Absolute Maximum Ratings" may cause permanent damage to the device. These are for stress ratings. Functional operation of the device at these or any other conditions beyond those indicated in the operational sections of the specifications is not implied. Exposure to absolute maximum rating conditions for extended periods may remain possibility to affect device reliability.

Note 2. θ_{JA} is measured in the natural convection at $T_A = 25^{\circ}C$ on a high effective thermal conductivity test board (4 Layers, 2S2P) of JEDEC 51-7 thermal measurement standard. The case point of θ_{JC} is on the expose pad for SOP-8 (Exposed Pad) package.

Note 3. Devices are ESD sensitive. Handling precaution is recommended.

Note 4. The device is not guaranteed to function outside its operating conditions.

Note 5. Quiescent, or ground current, is the difference between input and output currents. It is defined by $I_Q = I_{IN} - I_{OUT}$ under no load condition ($I_{OUT} = 0mA$).

Note 6. Regulation is measured at constant junction temperature by using a 2ms current pulse. Devices are tested for load regulation in the load range from 1mA to 2A.

Note 7. The dropout voltage is defined as $V_{IN} - V_{OUT}$, which is measured when V_{OUT} is $V_{OUT(NORMAL)} - 100mV$.

Typical Operating Characteristics

Load Transient Response

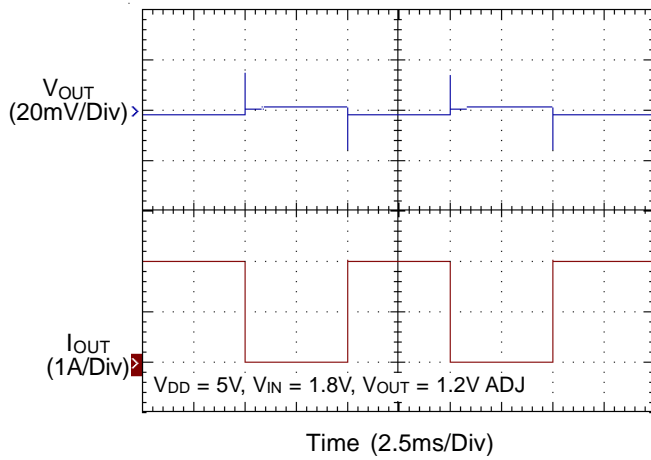

Load Transient Response

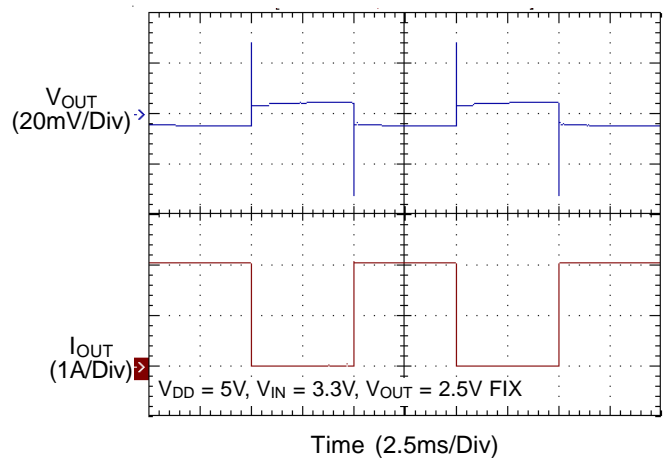

V_{IN} Line Transient Response

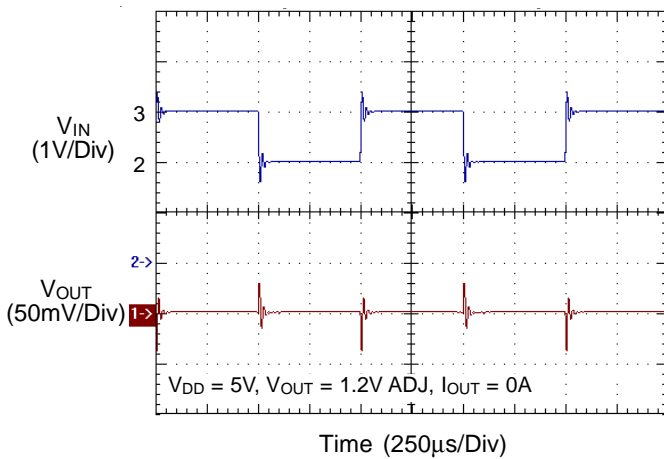

V_{IN} Line Transient Response

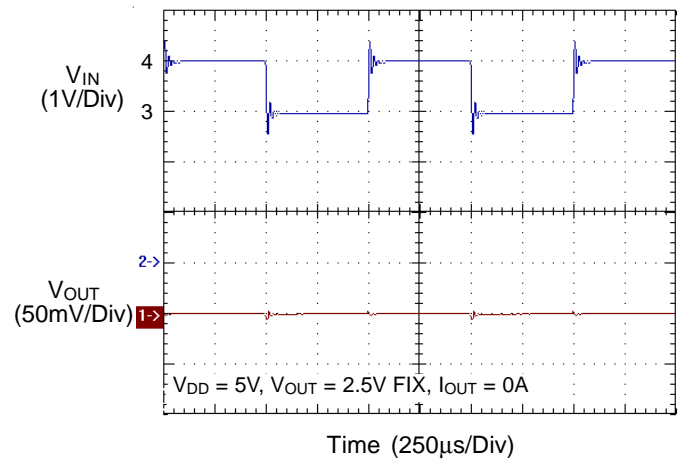

V_{DD} Line Transient Response

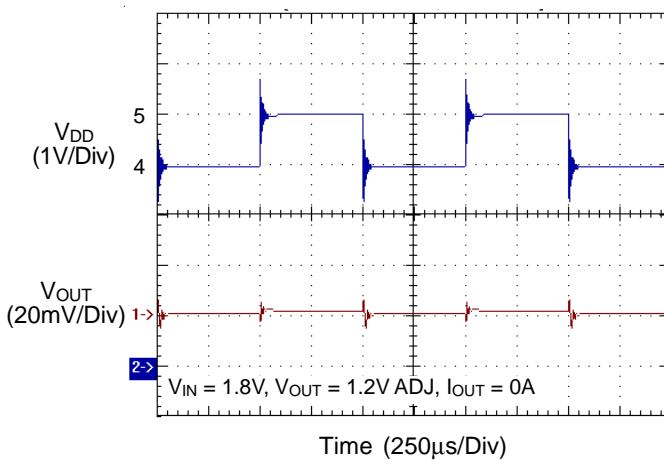

V_{DD} Line Transient Response

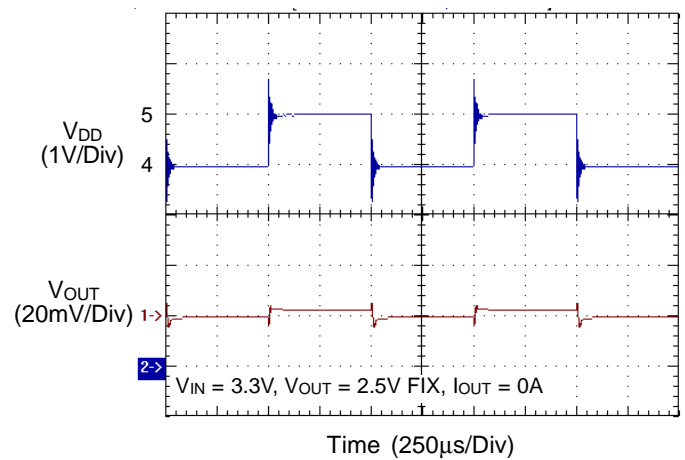

Dropout Voltage vs. Load Current

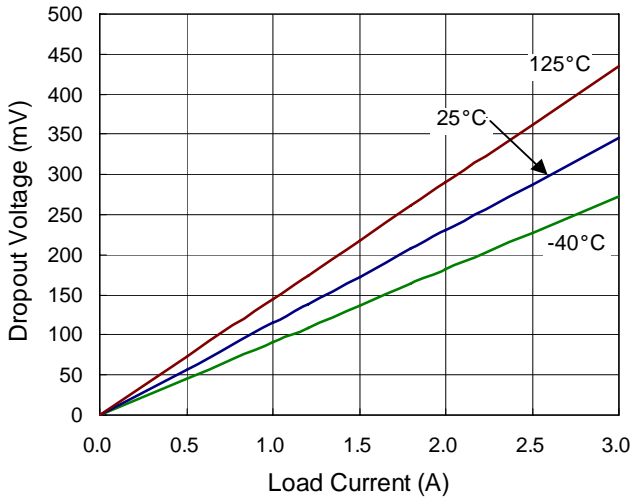

Start Up from Enable and PGOOD Delay

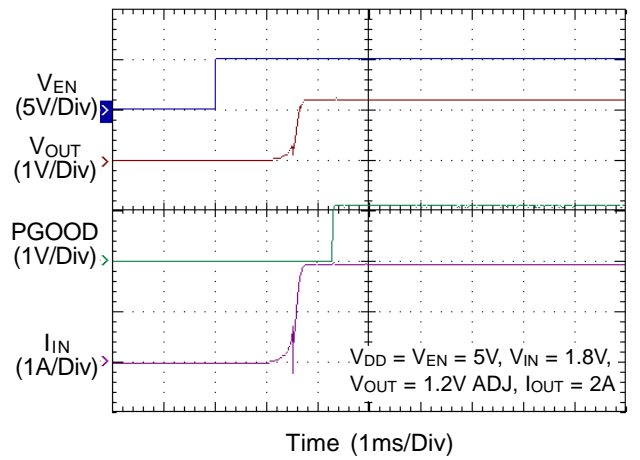

Start Up from V_{DD}

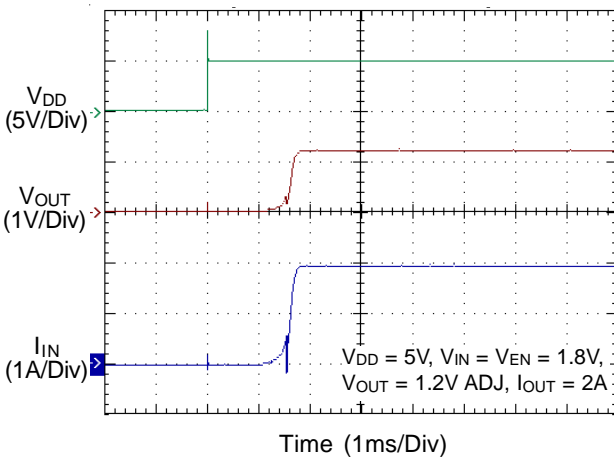

Start Up from V_{IN}

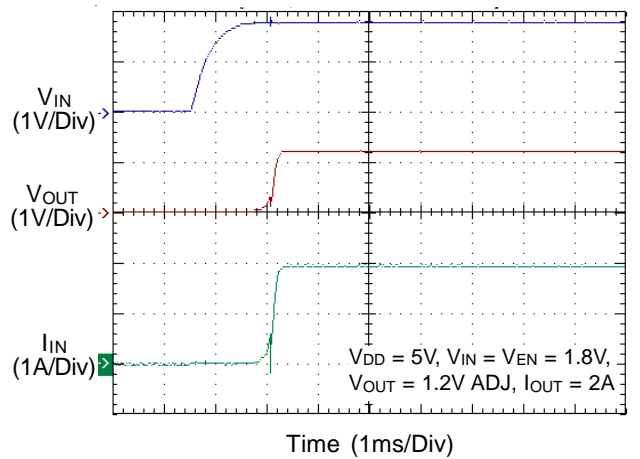

Short Circuit Protection

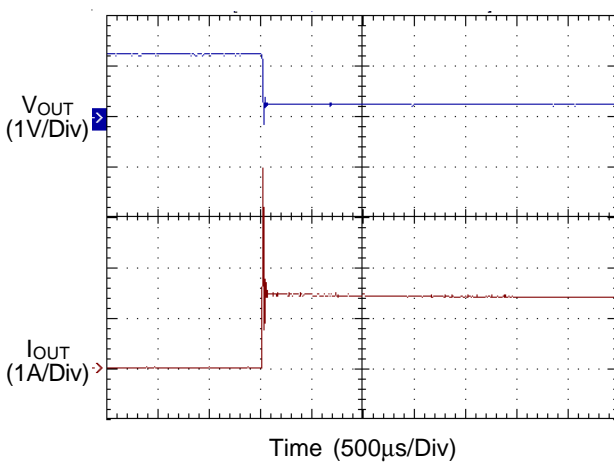

Short Circuit Current vs. Temperature

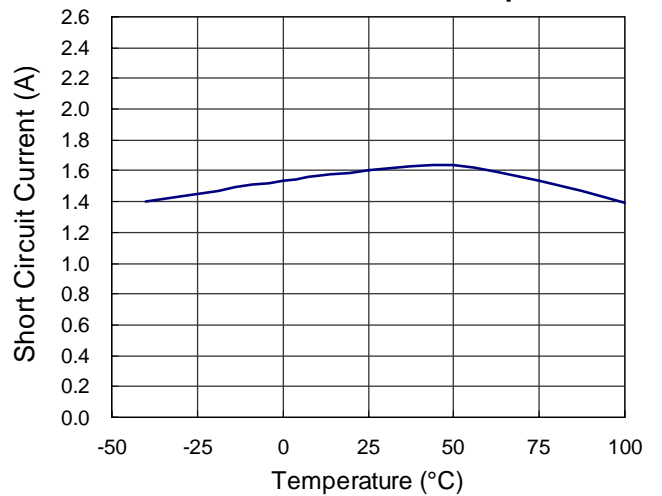

Enable Threshold Voltage vs. Temperature

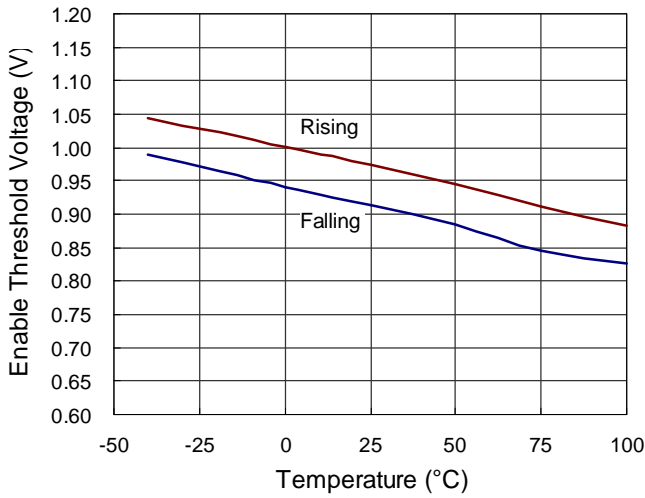

Quiescent Current vs. Temperature

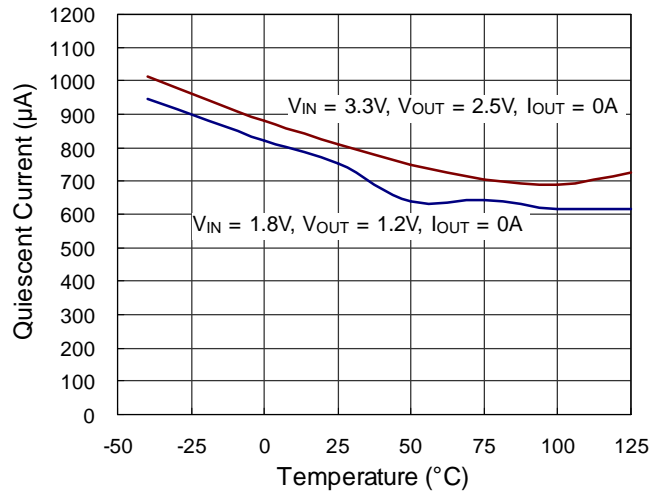

Fixed Output Voltage Range vs. Temperature

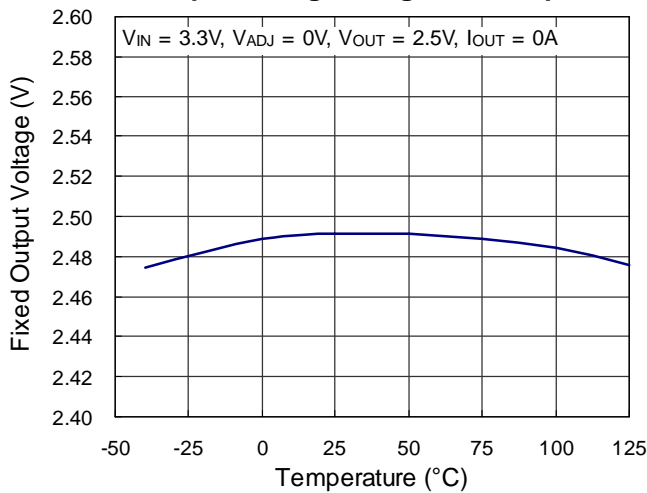

Reference Voltage vs. Temperature

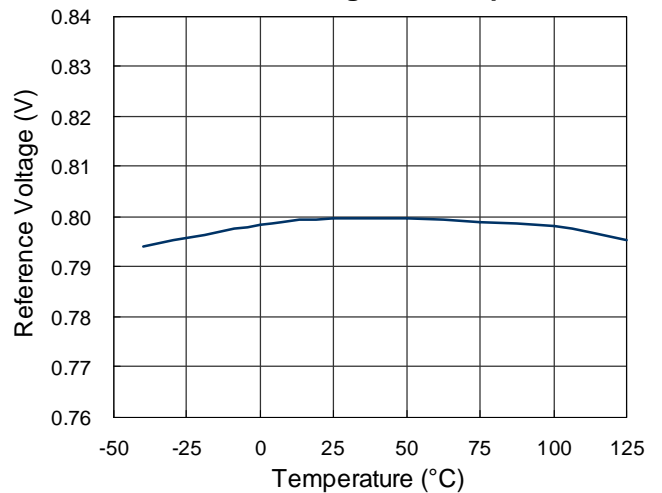

VDD POR Threshold Voltage vs. Temperature

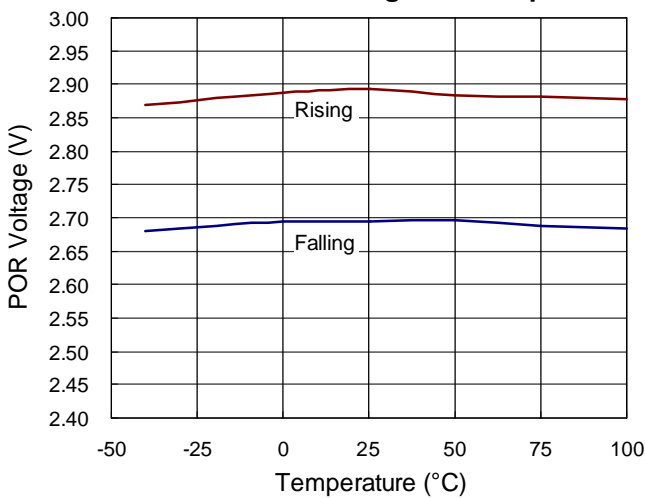

ADJ Threshold Voltage Range vs. Temperature

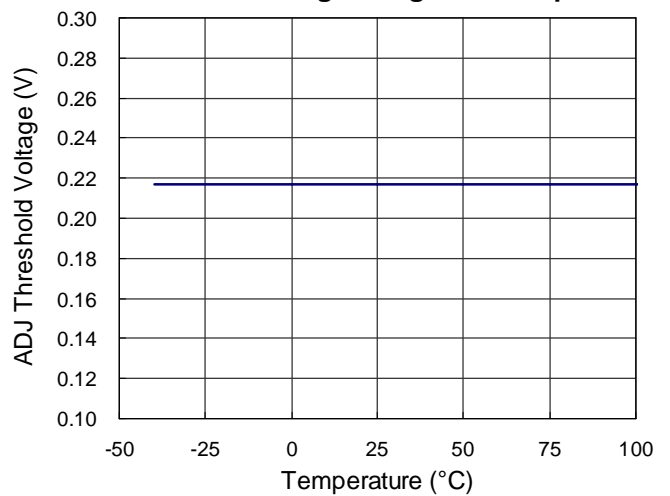

Application information

Adjustable Mode Operation

The output voltage of RT9042 is adjustable from 0.8V to V_{IN} by external voltage divider resistors as shown in Typical Application Circuit (Figure 2). The value of resistors R1 and R2 should be more than 10kΩ to reduce the power loss. The output voltage can be calculated by the following equation :

$$V_{OUT} = V_{REF} \times \left(1 + \frac{R1}{R2} \right)$$

where V_{REF} is the reference voltage (0.8V typical).

Enable

The RT9042 goes into shutdown mode when the EN pin is in the logic low condition. During this condition, the pass transistor, error amplifier, and band gap are turned off, reducing the supply current to 10μA typical. The RT9042 goes into operation mode when the EN pin is in the logic high condition. If the EN pin is floating, please notice the RT9042 internal initial logic level. For RT9042, the EN pin function pulls low level internally. So the regulator will be turn off when EN pin is floating.

Input Capacitor

Good bypassing is recommended from input to ground to improve AC performance. A 10μF input capacitor or greater located as close as possible to the IC is recommended.

Output Capacitor

The output capacitor must meet both requirements for minimum amount of capacitance and ESR in all LDOs application. The RT9042 is designed specifically to work with low ESR ceramic output capacitor in space-saving and performance consideration. Using a ceramic capacitor which value is at least 10μF with ESR is > 15mΩ on the RT9042 output ensures stability. The RT9042 still works well with output capacitor of other types due to the wide stable ESR range. Figure 3 shows the curves of allowable ESR range as a function of load current for various output capacitor values. Output capacitor of larger capacitance can reduce noise and improve load transient response, stability, and PSRR. The output capacitor should be located not more than 0.5 inch from the VOUT pin of the RT9042 and returned to a clean analog ground.

Region of Stable C_{OUT} ESR vs. Output Current

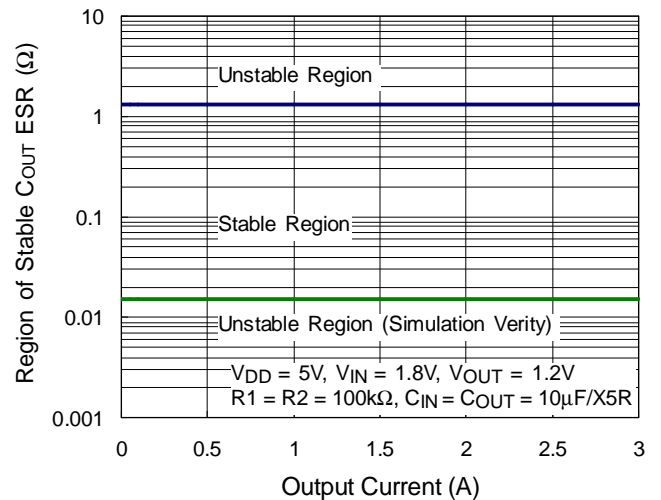

Figure 3. Region of Stable C_{OUT} ESR vs. Output Current

Current Limit

The RT9042 contains an independent current limit and the short circuit current protection to prevent unexpected applications. The current limit monitors and controls the pass transistor's gate voltage, limiting the output current to higher than 3.5A typical. When the output voltage is less than 0.2V, the short circuit current protection starts the current fold back function and maintains the loading current 1.8A. The output can be shorted to ground indefinitely without damaging the part.

Power Good

The power good function is an open-drain output. Connects 100kΩ pull up resistor to V_{OUT} to obtain an output voltage. The PGOOD pin will output high immediately after the output voltage arrives 90% of normal output voltage.

Thermal Shutdown Protection

Thermal protection limits power dissipation to prevent IC over temperature in RT9042. When the operation junction temperature exceeds 160°C, the over temperature protection circuit starts the thermal shutdown function and turns the pass transistor off. The pass transistor turns on again after the junction temperature cools by 30°C. RT9042 lowers its OTP trip level from 160°C to 90°C when output short circuit occurs ($V_{OUT} < 0.2V$). It limits

IC case temperature under 100°C and provides maximum safety to customer while output short circuit occurring.

Power Dissipation

For continuous operation, do not exceed absolute maximum operation junction temperature 125°C. The power dissipation definition in device is :

$$P_D = (V_{IN} - V_{OUT}) \times I_{OUT} + V_{IN} \times I_Q$$

The maximum power dissipation depends on the thermal resistance of IC package, PCB layout, the rate of surroundings airflow and temperature difference between junctions to ambient. The maximum power dissipation can be calculated by following formula :

$$P_{D(MAX)} = (T_{J(MAX)} - T_A) / \theta_{JA}$$

Where $T_{J(MAX)}$ is the maximum operation junction temperature 125°C, T_A is the ambient temperature and the θ_{JA} is the junction to ambient thermal resistance.

For recommended operating conditions specification of RT9042, the maximum junction temperature is 125°C. The junction to ambient thermal resistance for SOP-8 (Exposed Pad) package is 75°C/W on the standard JEDEC 51-7 (4 layers, 2S2P) thermal test board. The copper thickness is 2oz. The maximum power dissipation at $T_A = 25^\circ\text{C}$ can be calculated by following formula :

$$P_{D(MAX)} = (125^\circ\text{C} - 25^\circ\text{C}) / (75^\circ\text{C/W}) = 1.33\text{W}$$

(SOP-8 Exposed Pad on the minimum layout)

Layout Considerations

The thermal resistance θ_{JA} of SOP-8 (Exposed Pad) is determined by the package design and the PCB design. However, the package design had been designed. If possible, it's useful to increase thermal performance by the PCB design. The thermal resistance θ_{JA} can be decreased by adding a copper under the exposed pad of SOP-8 (Exposed Pad) package.

As shown in Figure 4, the amount of copper area to which the SOP-8 (Exposed Pad) is mounted affects thermal performance. When mounted to the standard SOP-8 (Exposed Pad) pad (Figure 4.a), θ_{JA} is 75°C/W. Adding copper area of pad under the SOP-8 (Exposed Pad) (Figure 4.b) reduces the θ_{JA} to 64°C/W. Even further, increasing the copper area of pad to 70mm² (Figure 4.e) reduces the θ_{JA} to 49°C/W.

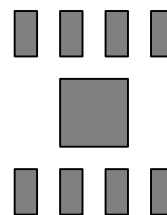

(a) Copper Area = (2.3 x 2.3) mm², $\theta_{JA} = 75^\circ\text{C/W}$

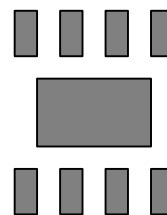

(b) Copper Area = 10mm², $\theta_{JA} = 64^\circ\text{C/W}$

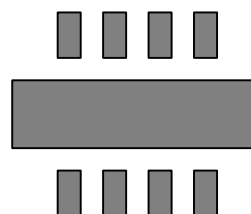

(c) Copper Area = 30mm², $\theta_{JA} = 54^\circ\text{C/W}$

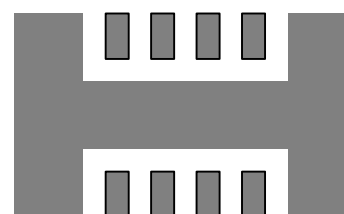

(d) Copper Area = 50mm², $\theta_{JA} = 51^\circ\text{C/W}$

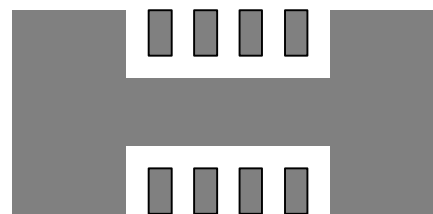

(e) Copper Area = 70mm², $\theta_{JA} = 49^\circ\text{C/W}$

Figure 4. Thermal Resistance vs. Copper Area Layout Thermal Design

The maximum power dissipation depends on operating ambient temperature for fixed $T_{J(MAX)}$ and thermal resistance θ_{JA} . For RT9042 packages, the Figure 5 of derating curves allows the designer to see the effect of rising ambient temperature on the maximum power allowed.

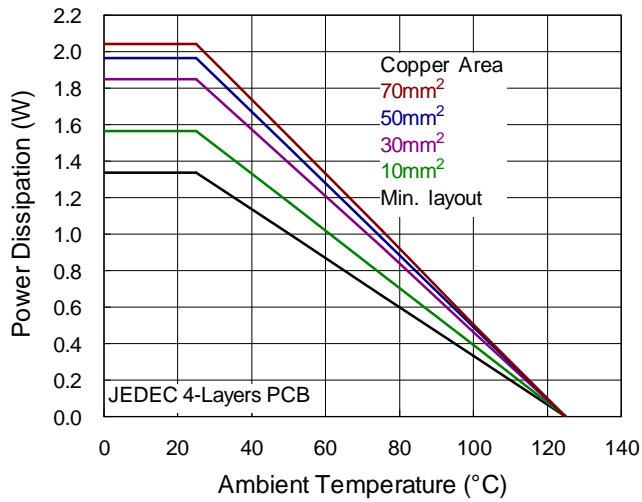
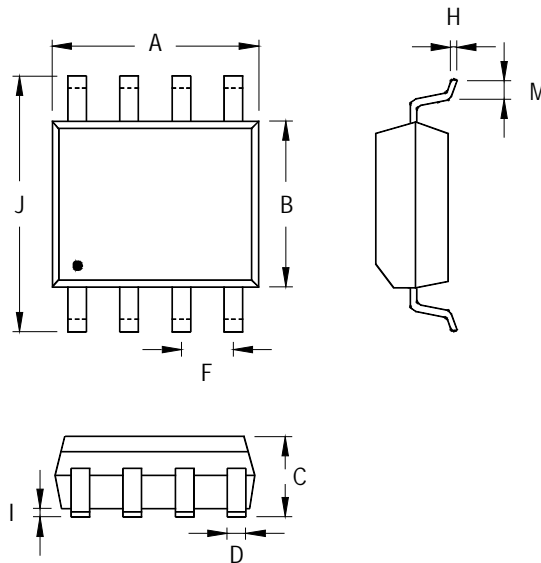

Figure 5. Derating Curve for Package

Outline Dimension



Symbol	Dimensions In Millimeters		Dimensions In Inches	
	Min	Max	Min	Max
A	4.801	5.004	0.189	0.197
B	3.810	3.988	0.150	0.157
C	1.346	1.753	0.053	0.069
D	0.330	0.508	0.013	0.020
F	1.194	1.346	0.047	0.053
H	0.170	0.254	0.007	0.010
I	0.050	0.254	0.002	0.010
J	5.791	6.200	0.228	0.244
M	0.400	1.270	0.016	0.050

8-Lead SOP Plastic Package

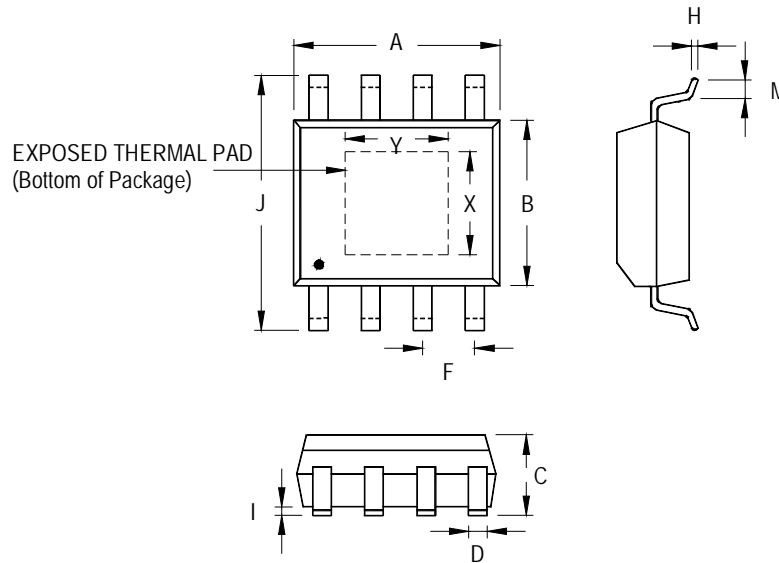

Symbol	Dimensions In Millimeters		Dimensions In Inches		
	Min	Max	Min	Max	
A	4.801	5.004	0.189	0.197	
B	3.810	4.000	0.150	0.157	
C	1.346	1.753	0.053	0.069	
D	0.330	0.510	0.013	0.020	
F	1.194	1.346	0.047	0.053	
H	0.170	0.254	0.007	0.010	
I	0.000	0.152	0.000	0.006	
J	5.791	6.200	0.228	0.244	
M	0.406	1.270	0.016	0.050	
Option 1	X	2.000	2.300	0.079	0.091
	Y	2.000	2.300	0.079	0.091
Option 2	X	2.100	2.500	0.083	0.098
	Y	3.000	3.500	0.118	0.138

8-Lead SOP (Exposed Pad) Plastic Package

Richtek Technology Corporation

Headquarter
 5F, No. 20, Taiyuen Street, Chupei City
 Hsinchu, Taiwan, R.O.C.
 Tel: (8863)5526789 Fax: (8863)5526611

Richtek Technology Corporation

Taipei Office (Marketing)
 5F, No. 95, Minchiuan Road, Hsintien City
 Taipei County, Taiwan, R.O.C.
 Tel: (8862)86672399 Fax: (8862)86672377
 Email: marketing@richtek.com

Information that is provided by Richtek Technology Corporation is believed to be accurate and reliable. Richtek reserves the right to make any change in circuit design, specification or other related things if necessary without notice at any time. No third party intellectual property infringement of the applications should be guaranteed by users when integrating Richtek products into any application. No legal responsibility for any said applications is assumed by Richtek.