

High Power RF LDMOS Field Effect Transistor 300 W, 2110 – 2170 MHz

Description

The PTFB213004F is a 300-watt LDMOS FET designed for class AB operation in cellular amplifiers covering the 2110 to 2170 MHz frequency band. Features include high peak power, input and output match, and a thermally-enhanced, open-cavity earless ceramic package.

PTFB213004F
Package H-37275-6/2

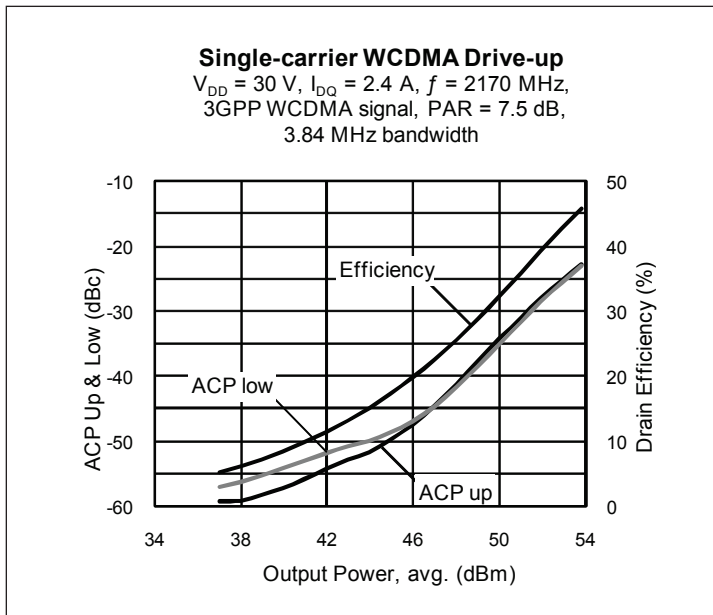
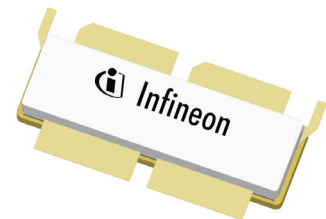

Features

- Broadband internal matching
- Enhanced for use in DPD error correction systems
- Wide video bandwidth
- Typical single-carrier WCDMA performance at 2170 MHz, 30 V
 - $P_{OUT} = 49.5\text{ dBm Avg}$
 - Gain = 17.5 dB
 - Efficiency = 30%
- Increased negative gate-source voltage range for improved performance in Doherty amplifiers
- Capable of handling 10:1 VSWR @ 30 V, 300 W (CW) output power
- Excellent thermal stability
- Integrated ESD protection
- Pb-free and RoHS-compliant

RF Characteristics

Two-carrier WCDMA Measurements (tested in Infineon test fixture)

$V_{DD} = 30\text{ V}$, $I_{DQ} = 2.4\text{ A}$, $P_{OUT} = 60\text{ W average}$,
 $f_1 = 2167.5\text{ MHz}$, $f_2 = 2172.5\text{ MHz}$, 3GPP signal, channel bandwidth = 3.84 MHz, PAR = 7.5 dB @ 0.01% CCDF

Characteristic	Symbol	Min	Typ	Max	Unit
Gain	G_{ps}	17	18	—	dB
Drain Efficiency	η_D	25	26.5	—	%
Intermodulation Distortion	IMD	—	-36	-33	dBc

All published data at $T_{CASE} = 25^\circ\text{C}$ unless otherwise indicated

ESD: Electrostatic discharge sensitive device—observe handling precautions!

RF Characteristics (cont.)

Two-tone Measurements (not subject to production test—verified by design / characterization in Infineon test fixture)
 $V_{DD} = 30\text{ V}$, $I_{DQ} = 2.4\text{ A}$, $P_{OUT} = 250\text{ W PEP}$, $f = 2140\text{ MHz}$, tone spacing = 1 MHz

Characteristic	Symbol	Min	Typ	Max	Unit
Gain	G_{ps}	—	18	—	dB
Drain Efficiency	η_D	—	37	—	%
Intermodulation Distortion	IMD	—	-30	—	dBc

DC Characteristics

Characteristic	Conditions	Symbol	Min	Typ	Max	Unit
Drain-Source Breakdown Voltage	$V_{GS} = 0\text{ V}$, $I_{DS} = 10\text{ }\mu\text{A}$	$V_{(BR)DSS}$	65	—	—	V
Drain Leakage Current	$V_{DS} = 30\text{ V}$, $V_{GS} = 0\text{ V}$	I_{DSS}	—	—	1.0	μA
	$V_{DS} = 63\text{ V}$, $V_{GS} = 0\text{ V}$	I_{DSS}	—	—	10.0	μA
On-State Resistance	$V_{GS} = 10\text{ V}$, $V_{DS} = 0.1\text{ A}$	$R_{DS(on)}$	—	0.03	—	Ω
Operating Gate Voltage	$V_{DS} = 30\text{ V}$, $I_{DQ} = 2.4\text{ A}$	V_{GS}	2.3	2.8	3.3	V
Gate Leakage Current	$V_{GS} = 10\text{ V}$, $V_{DS} = 0\text{ V}$	I_{GSS}	—	—	1.0	μA

Maximum Ratings

Parameter	Symbol	Value	Unit
Drain-Source Voltage	V_{DSS}	-0.5 to +65	V
Gate-Source Voltage	V_{GS}	-6 to +10	V
Junction Temperature	T_J	200	$^{\circ}\text{C}$
Storage Temperature Range	T_{STG}	-40 to +150	$^{\circ}\text{C}$
Thermal Resistance ($T_{CASE} = 70^{\circ}\text{C}$)	$R_{\theta JC}$	0.23	$^{\circ}\text{C/W}$

Ordering Information

Type and Version	Order Code	Package Description	Shipping
PTFB213004F V2 R0	PTFB213004FV2R0XTMA1	H-37275-6/2, earless flange	Tape & Reel, 50 pcs
PTFB213004F V2 R250	PTFB213004FV2R250XTMA1	H-37275-6/2, earless flange	Tape & Reel, 250 pcs

Typical Performance (data taken in a production test fixture)

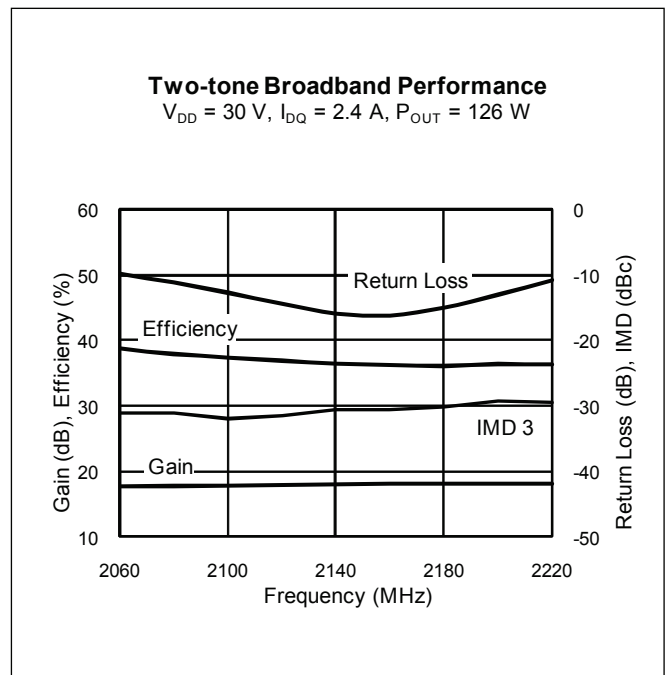
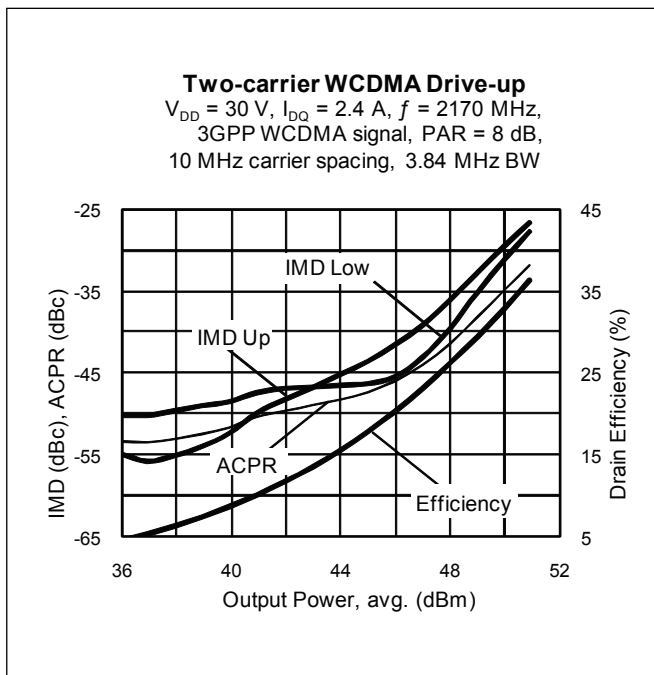
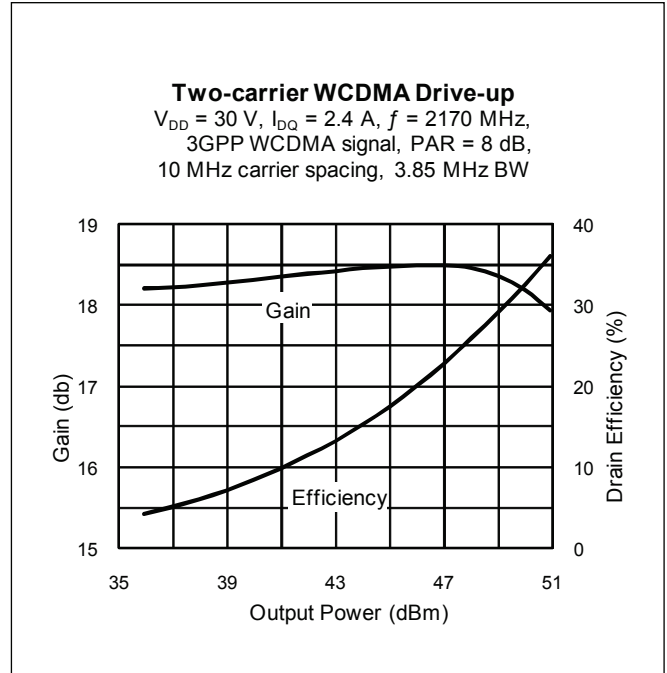
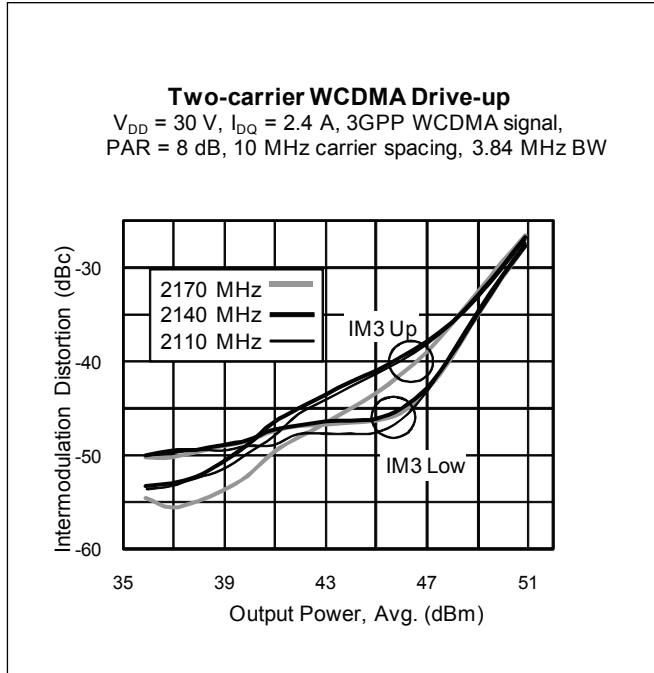

Typical Performance (cont.)

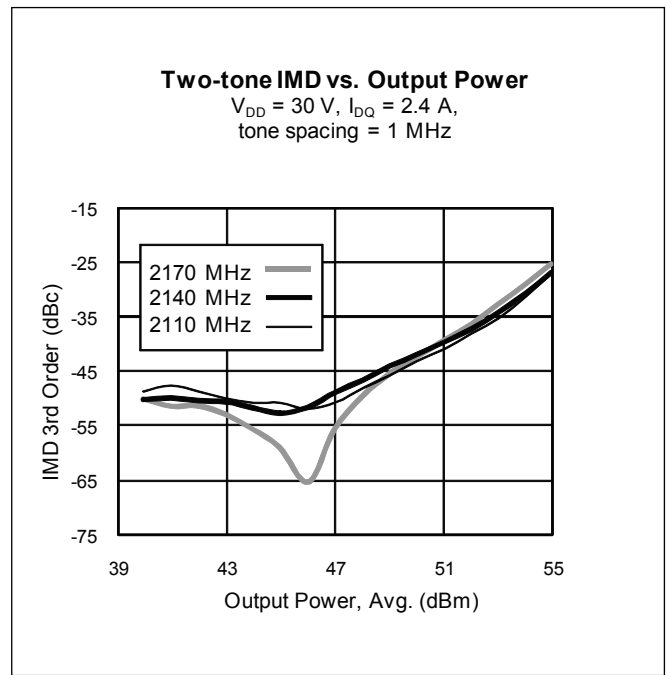
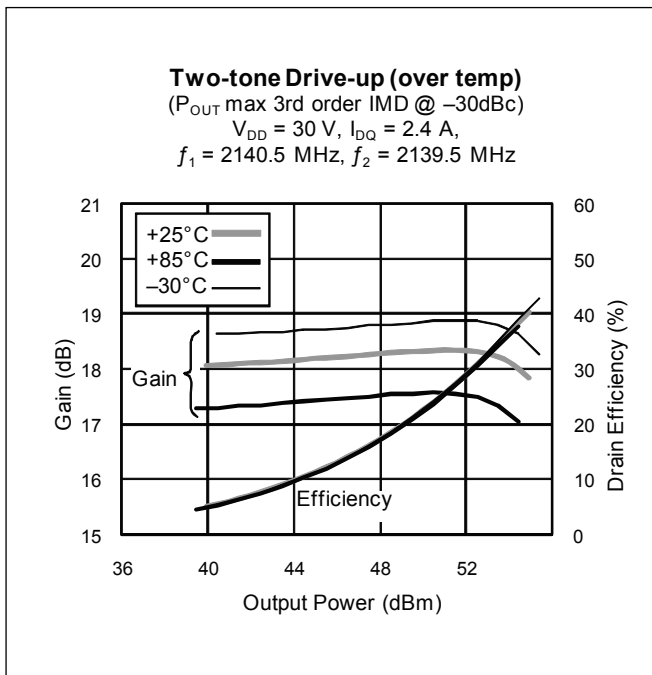
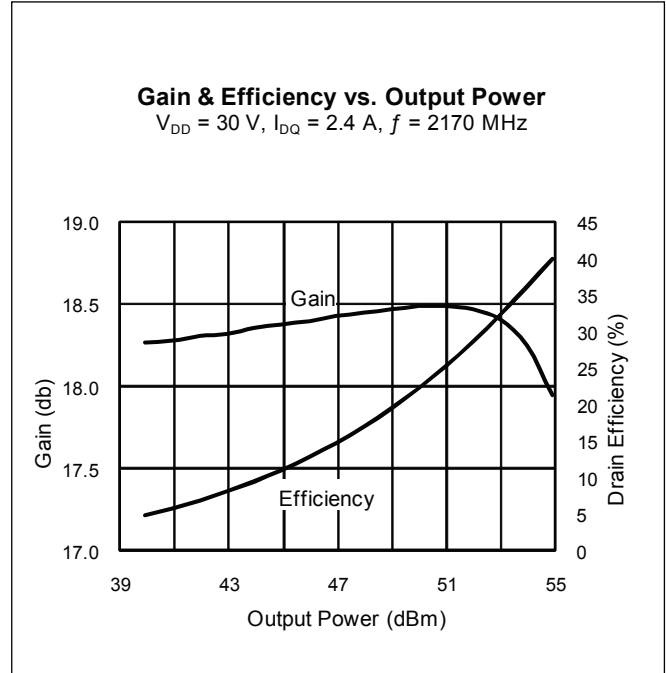
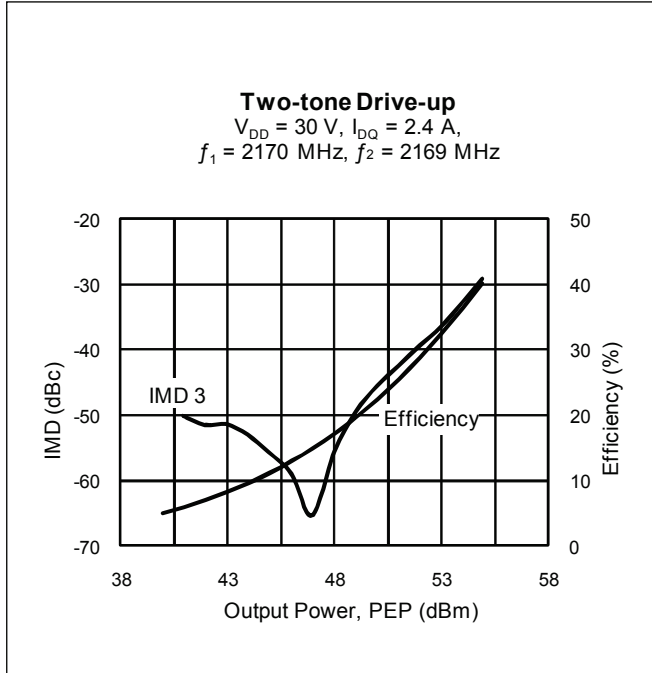

Typical Performance (cont.)

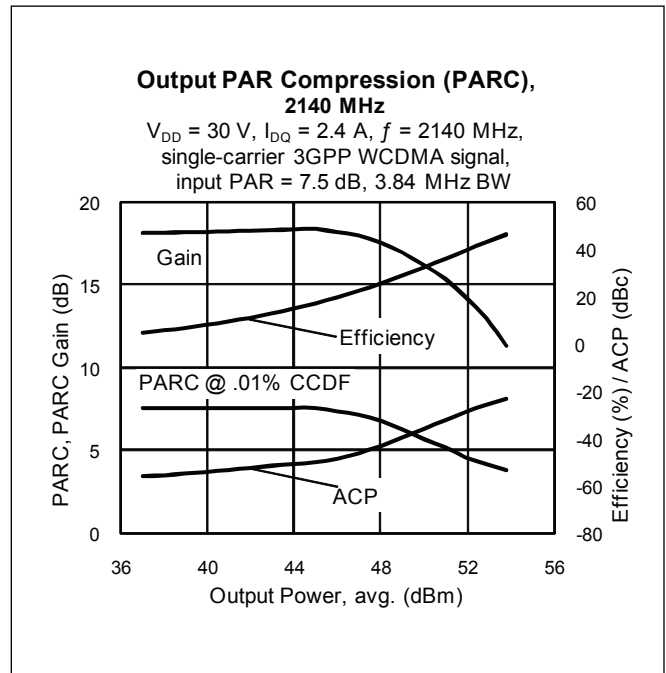
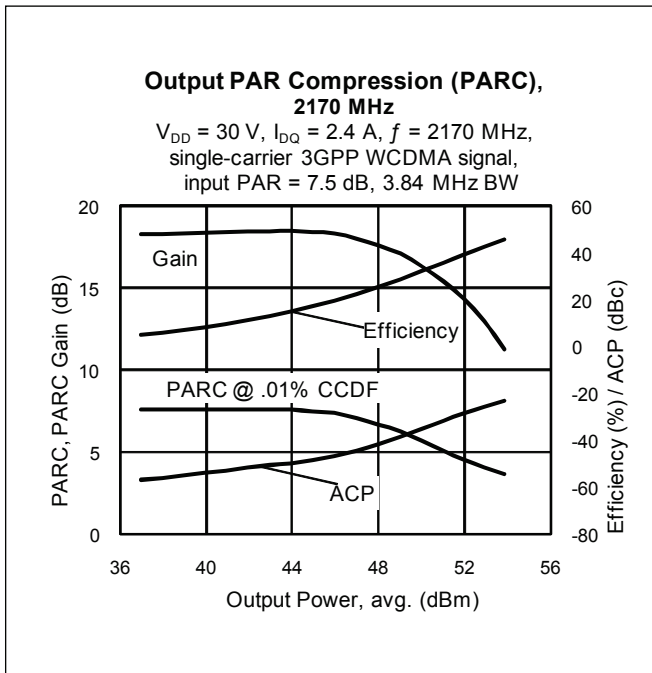
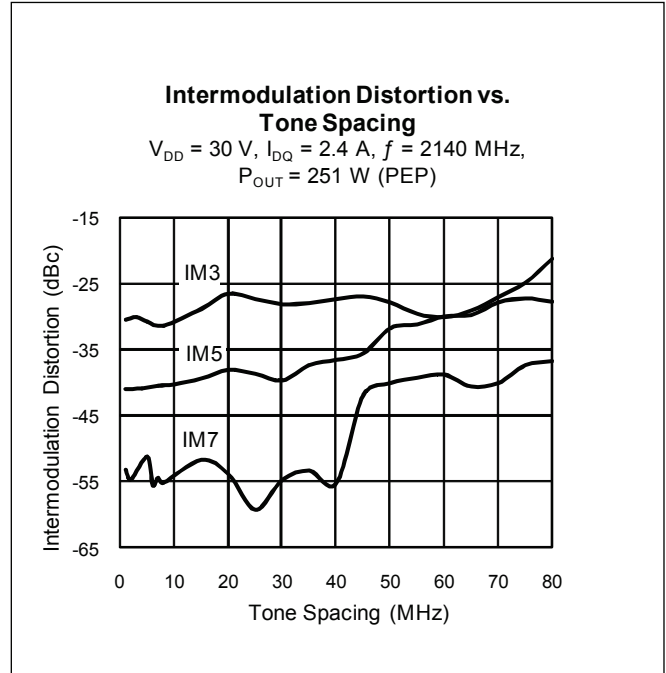
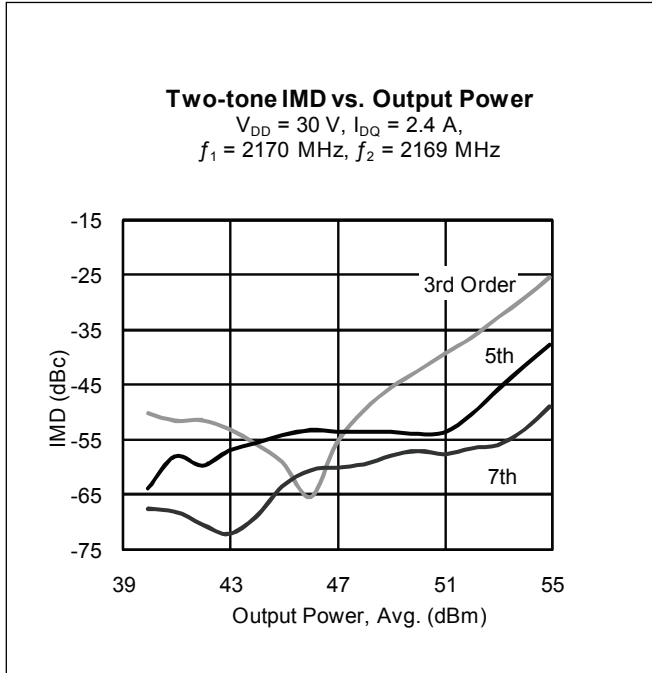

Typical Performance (cont.)

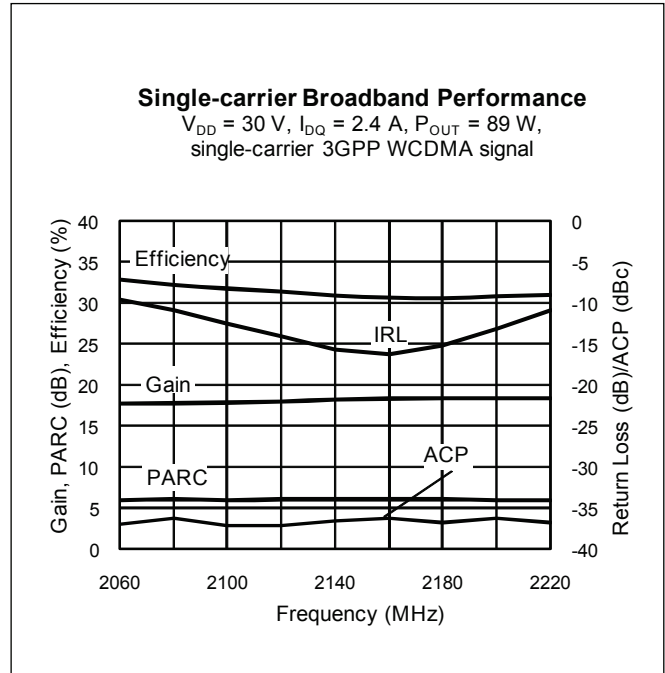
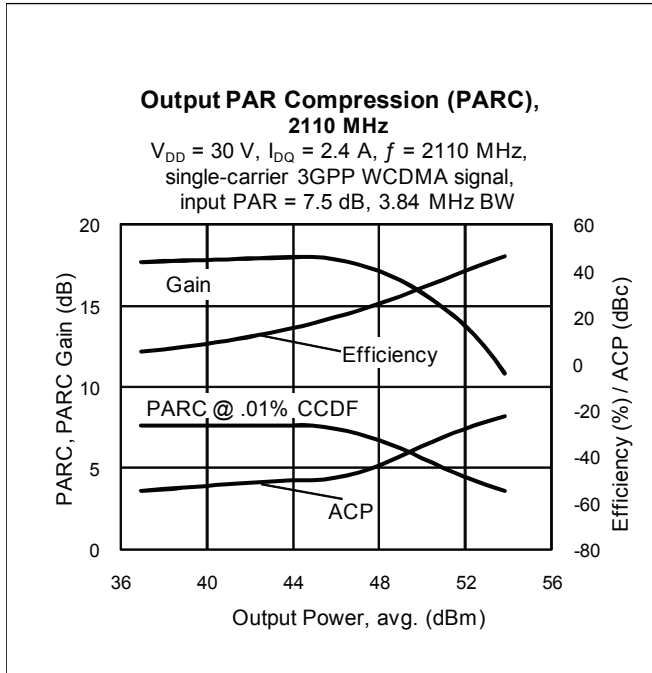

Broadband Circuit Impedance

Frequency MHz	Z Source Ω		Z Load Ω	
	R	jX	R	jX
2080	1.55	-4.57	0.71	-2.91
2090	1.54	-4.52	0.71	-2.89
2100	1.52	-4.48	0.70	-2.86
2110	1.51	-4.44	0.70	-2.84
2120	1.50	-4.40	0.70	-2.81
2130	1.48	-4.36	0.70	-2.79
2140	1.47	-4.32	0.70	-2.77
2150	1.46	-4.28	0.70	-2.74
2160	1.45	-4.24	0.69	-2.72
2170	1.43	-4.20	0.69	-2.70
2180	1.42	-4.17	0.69	-2.67
2190	1.41	-4.13	0.69	-2.65
2200	1.40	-4.09	0.69	-2.63

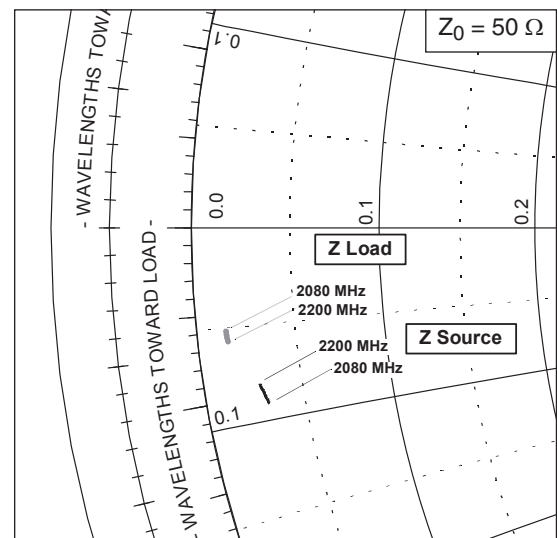
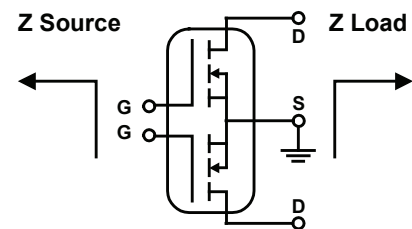

Reference Circuit (cont.)

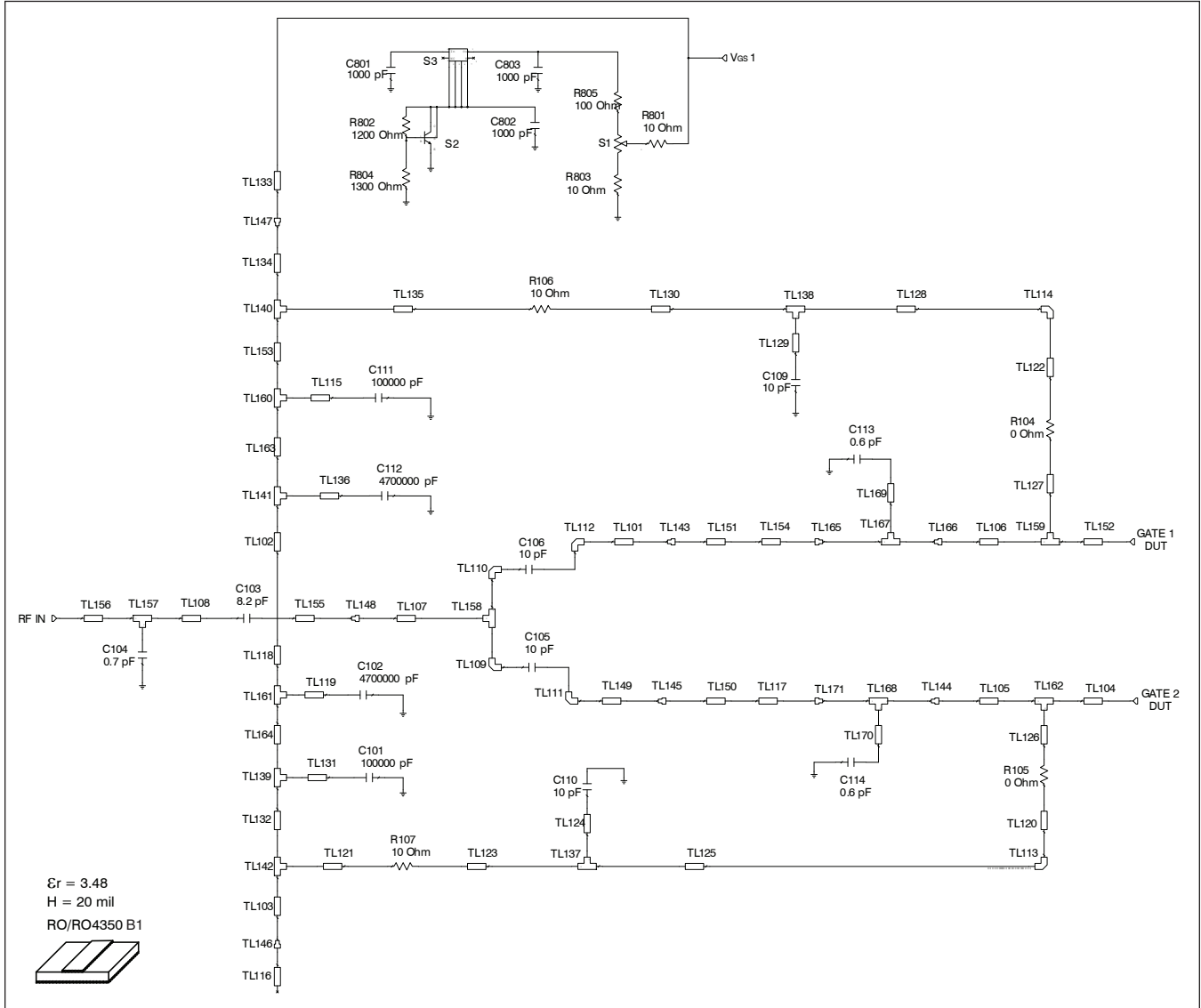

Reference circuit input schematic for $f = 2170 \text{ MHz}$

Reference Circuit (cont.)

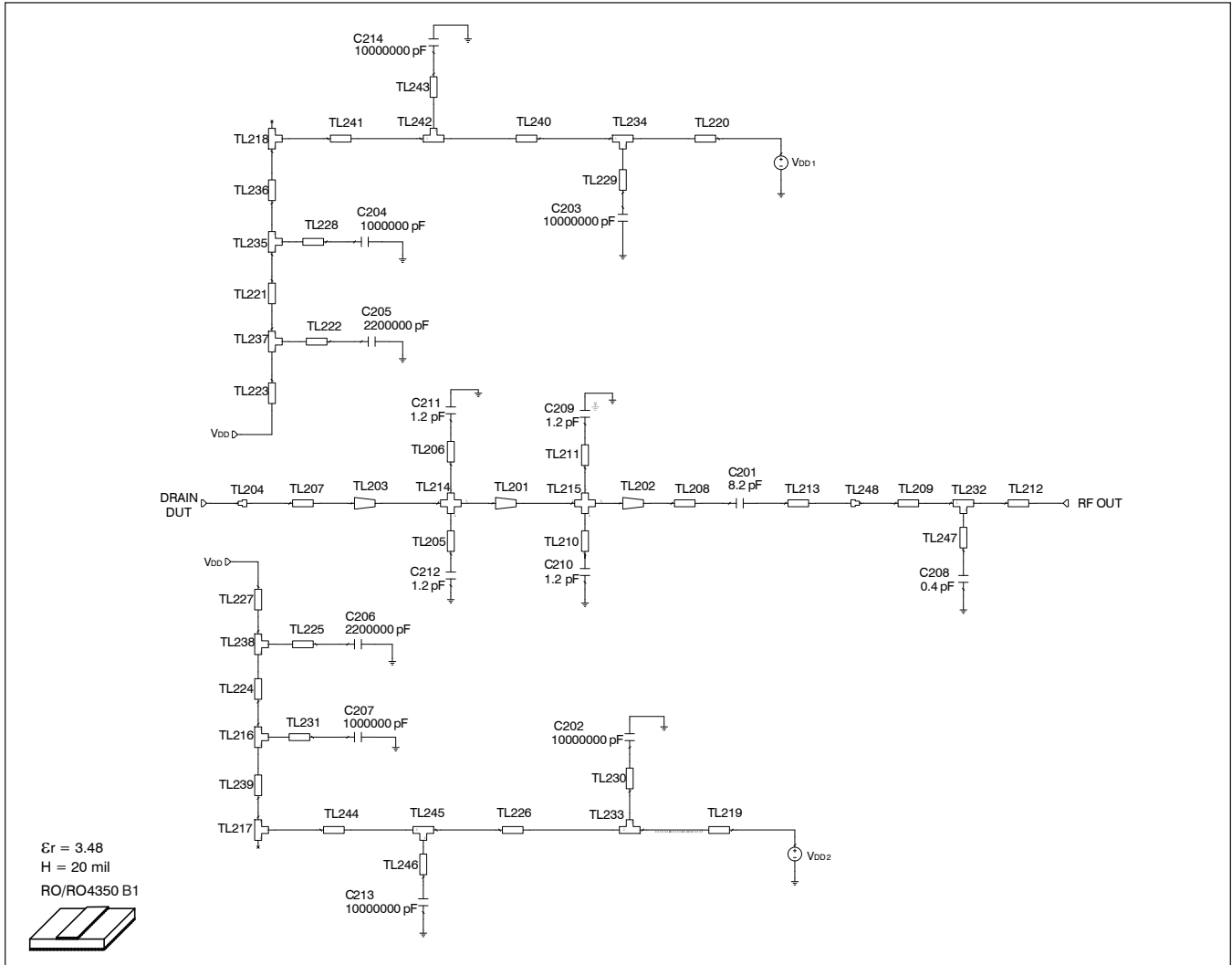

Reference circuit output schematic for $f = 2170 \text{ MHz}$

Reference Circuit (cont.)

Description

DUT	PTFB213004F	LD MOS Transistor	
PCB	LTN/PTFB213004EF	0.508 mm [.020"] thick, $\epsilon_r = 3.48$	Rogers 4350, 1 oz. copper

Electrical Characteristics at 2170 MHz

Transmission Line	Electrical Characteristics	Dimensions: mm	Dimensions: mils
Input			
TL101	0.004λ , 51.98 Ω	$W1 = 1.087$, $W2 = 1.087$, $W3 = 0.813$	$W1 = 43$, $W2 = 43$, $W3 = 32$
TL101	0.010λ , 28.85 Ω	$W = 2.540$, $L = 0.787$	$W = 100$, $L = 31$
TL102	0.207λ , 63.89 Ω	$W = 0.762$, $L = 17.526$	$W = 30$, $L = 690$
TL103	0.006λ , 63.89 Ω	$W = 0.762$, $L = 0.508$	$W = 30$, $L = 20$
TL104	0.070λ , 8.03 Ω	$W = 11.430$, $L = 5.359$	$W = 450$, $L = 211$
TL105, TL106	0.017λ , 8.03 Ω	$W = 11.430$, $L = 1.270$	$W = 450$, $L = 50$
TL107	0.025λ , 32.60 Ω	$W = 2.159$, $L = 2.032$	$W = 85$, $L = 80$
TL108	0.015λ , 49.69 Ω	$W = 1.168$, $L = 1.270$	$W = 46$, $L = 50$
TL109, TL110, TL111, TL112		$W = 2.540$	$W = 100$
TL113, TL114		$W = 1.016$	$W = 40$
TL115, TL131	0.000λ , 41.75 Ω	$W = 1.524$, $L = 0.025$	$W = 60$, $L = 1$
TL116, TL133	0.016λ , 34.08 Ω	$W = 2.032$, $L = 1.270$	$W = 80$, $L = 50$
TL117	0.016λ , 17.20 Ω	$W = 4.826$, $L = 1.270$	$W = 190$, $L = 50$
TL118	0.041λ , 63.89 Ω	$W = 0.762$, $L = 3.480$	$W = 30$, $L = 137$
TL119, TL136	0.000λ , 41.75 Ω	$W = 1.524$, $L = 0.025$	$W = 60$, $L = 1$
TL120, TL122	0.015λ , 54.17 Ω	$W = 1.016$, $L = 1.262$	$W = 40$, $L = 50$
TL121, TL135	0.020λ , 54.17 Ω	$W = 1.016$, $L = 1.651$	$W = 40$, $L = 65$
TL123, TL130	0.017λ , 54.17 Ω	$W = 1.016$, $L = 1.397$	$W = 40$, $L = 55$
TL124, TL129	0.000λ , 34.08 Ω	$W = 2.032$, $L = 0.025$	$W = 80$, $L = 1$
TL125, TL128	0.091λ , 54.17 Ω	$W = 1.016$, $L = 7.620$	$W = 40$, $L = 300$
TL126, TL127	0.009λ , 54.17 Ω	$W = 1.016$, $L = 0.762$	$W = 40$, $L = 30$
TL132	0.018λ , 63.89 Ω	$W = 0.762$, $L = 1.524$	$W = 30$, $L = 60$
TL134	0.006λ , 63.89 Ω	$W = 0.762$, $L = 0.508$	$W = 30$, $L = 20$
TL137, TL138	0.024λ , 54.17 Ω	$W1 = 1.016$, $W2 = 1.016$, $W3 = 2.032$	$W1 = 40$, $W2 = 40$, $W3 = 80$
TL139, TL141	0.018λ , 63.89 Ω	$W1 = 0.762$, $W2 = 0.762$, $W3 = 1.524$	$W1 = 30$, $W2 = 30$, $W3 = 60$
TL140, TL142	0.012λ , 63.89 Ω	$W1 = 0.762$, $W2 = 0.762$, $W3 = 1.016$	$W1 = 30$, $W2 = 30$, $W3 = 40$
TL143		$W1 = 0.003$, $W2 = 0.005$, Offset = 0.000	$W1 = 3$, $W2 = 190$, Offset = 10
TL144		$W1 = 0.005$, $W2 = 0.011$, Offset = -0.003	$W1 = 5$, $W2 = 450$, Offset = -130
TL145		$W1 = 0.003$, $W2 = 0.005$, Offset = 0.000	$W1 = 3$, $W2 = 190$, Offset = -10
TL146		$W1 = 2.032$, $W2 = 0.762$	$W1 = 80$, $W2 = 30$
TL147		$W1 = 2.540$, $W2 = 0.762$	$W1 = 100$, $W2 = 30$
TL148		$W1 = 1.168$, $W2 = 2.159$	$W1 = 46$, $W2 = 85$
TL149	0.009λ , 28.85 Ω	$W = 2.540$, $L = 0.762$	$W = 100$, $L = 30$
TL150, TL151	0.006λ , 17.20 Ω	$W = 4.826$, $L = 0.508$	$W = 190$, $L = 20$

table continued on page 10

Reference Circuit (cont.)

Electrical Characteristics at 2170 MHz

Transmission Line	Electrical Characteristics	Dimensions: mm	Dimensions: mils
Input			
TL152	0.070 λ , 8.03 Ω	W = 11.430, L = 5.359	W = 450, L = 211
TL153	0.018 λ , 63.89 Ω	W = 0.762, L = 1.524	W = 30, L = 60
TL154	0.016 λ , 17.20 Ω	W = 4.826, L = 1.270	W = 190, L = 50
TL155	0.060 λ , 49.69 Ω	W = 1.168, L = 5.022	W = 46, L = 198
TL156	0.002 λ , 49.69 Ω	W = 1.168, L = 0.203	W = 46, L = 8
TL157	0.015 λ , 49.69 Ω	W1 = 1.168, W2 = 1.168, W3 = 1.270	W1 = 46, W2 = 46, W3 = 50
TL158	0.027 λ , 28.85 Ω	W1 = 2.540, W2 = 2.540, W3 = 2.159	W1 = 100, W2 = 100, W3 = 85
TL159, TL162	0.013 λ , 8.03 Ω	W1 = 11.430, W2 = 11.430, W3 = 1.016	W1 = 450, W2 = 450, W3 = 40
TL160, TL161	0.018 λ , 63.89 Ω	W1 = 0.762, W2 = 0.762, W3 = 1.524	W1 = 30, W2 = 30, W3 = 60
TL163, TL164	0.004 λ , 63.89 Ω	W = 0.762, L = 0.330	W = 30, L = 13
TL165, TL171		W1 = 0.011, W2 = 0.003, Offset = 0.005	W1 = 11, W2 = 100, Offset = 200
TL166		W1 = 0.005, W2 = 0.011, Offset = 0.003	W1 = 5, W2 = 450, Offset = 130
TL167		W1 = 0.000, W2 = 0.000, W3 = 0.000	W1 = 0, W2 = 1, W3 = 1
TL168	0.000 λ , 148.22 Ω	W1 = 0.013, W2 = 0.013, W3 = 0.013	W1 = 1, W2 = 1, W3 = 1
TL169	0.000 λ , 102.05 Ω	W = 0.254, L = 0.025	W = 10, L = 1
TL170	0.000 λ , 47.12 Ω	W = 1.270, L = 0.025	W = 50, L = 1

See next page for reference circuit output characteristics

Reference Circuit (cont.)

Electrical Characteristics at 2170 MHz

Transmission Line	Electrical Characteristics	Dimensions: mm	Dimensions: mils
Output			
TL201 (taper)	0.018 λ , 5.40 Ω / 9.59 Ω	W1 = 17.526, W2 = 9.398, L = 1.397	W1 = 690, W2 = 370, L = 55
TL202 (taper)	0.016 λ , 9.59 Ω / 34.72 Ω	W1 = 9.398, W2 = 1.981, L = 1.270	W1 = 370, W2 = 78, L = 50
TL203 (taper)	0.026 λ , 3.67 Ω / 5.40 Ω	W1 = 26.365, W2 = 17.526, L = 1.956	W1 = 1038, W2 = 690, L = 77
TL204		W1 = 25.400, W2 = 26.365	W1 = 1000, W2 = 1038
TL205, TL206, TL210, TL211	0.000 λ , 144.35 Ω	W = 0.025, L = 0.025	W = 1, L = 1
TL207	0.064 λ , 3.67 Ω	W = 26.365, L = 4.801	W = 1038, L = 189
TL208	0.050 λ , 34.72 Ω	W = 1.981, L = 4.115	W = 78, L = 162
TL209	0.028 λ , 47.12 Ω	W = 1.270, L = 2.337	W = 50, L = 92
TL212	0.053 λ , 47.12 Ω	W = 1.270, L = 4.394	W = 50, L = 173
TL213	0.016 λ , 28.85 Ω	W = 2.540, L = 1.270	W = 100, L = 50
TL214		W1 = 17.526, W2 = 0.025, W3 = 17.526, W4 = 0.025	W1 = 690, W2 = 1, W3 = 690, W4 = 1
TL215		W1 = 9.398, W2 = 0.025, W3 = 9.398, W4 = 0.025	W1 = 370, W2 = 1, W3 = 370, W4 = 1
TL216	0.022 λ , 20.93 Ω	W1 = 3.810, W2 = 3.810, W3 = 1.778	W1 = 150, W2 = 150, W3 = 70
TL217, TL218	0.048 λ , 20.93 Ω	W1 = 3.810, W2 = 3.810, W3 = 3.810	W1 = 150, W2 = 150, W3 = 150
TL219, TL220	0.017 λ , 20.93 Ω	W = 3.810, L = 1.372	W = 150, L = 54
TL221	0.008 λ , 20.93 Ω	W = 3.810, L = 0.635	W = 150, L = 25
TL222, TL225, TL228, TL231	0.000 λ , 37.51 Ω	W = 1.778, L = 0.025	W = 70, L = 1
TL223	0.032 λ , 20.93 Ω	W = 3.810, L = 2.540	W = 150, L = 100
TL224	0.008 λ , 20.93 Ω	W = 3.810, L = 0.635	W = 150, L = 25
TL226	0.165 λ , 20.93 Ω	W = 3.810, L = 13.106	W = 150, L = 516
TL227	0.032 λ , 20.93 Ω	W = 3.810, L = 2.540	W = 150, L = 100
TL229, TL230	0.000 λ , 20.93 Ω	W = 3.810, L = 0.025	W = 150, L = 1
TL232	0.024 λ , 47.12 Ω	W1 = 1.270, W2 = 1.270, W3 = 2.032	W1 = 50, W2 = 50, W3 = 80
TL233, TL234	0.048 λ , 20.93 Ω	W1 = 3.810, W2 = 3.810, W3 = 3.810	W1 = 150, W2 = 150, W3 = 150
TL235, TL237, TL238	0.022 λ , 20.93 Ω	W1 = 3.810, W2 = 3.810, W3 = 1.778	W1 = 150, W2 = 150, W3 = 70
TL236, TL239	0.018 λ , 20.93 Ω	W = 3.810, L = 1.397	W = 150, L = 55
TL240	0.165 λ , 20.93 Ω	W = 3.810, L = 13.106	W = 150, L = 516
TL241	0.006 λ , 20.93 Ω	W = 3.810, L = 0.508	W = 150, L = 20
TL242, TL245	0.026 λ , 20.93 Ω	W1 = 3.810, W2 = 3.810, W3 = 2.032	W1 = 150, W2 = 150, W3 = 80
TL243, TL246, TL247	0.000 λ , 34.08 Ω	W = 2.032, L = 0.025	W = 80, L = 1
TL244	0.006 λ , 20.93 Ω	W = 3.810, L = 0.508	W = 150, L = 20
TL248		W1 = 2.540, W2 = 1.270	W1 = 100, W2 = 50

Reference Circuit (cont.)

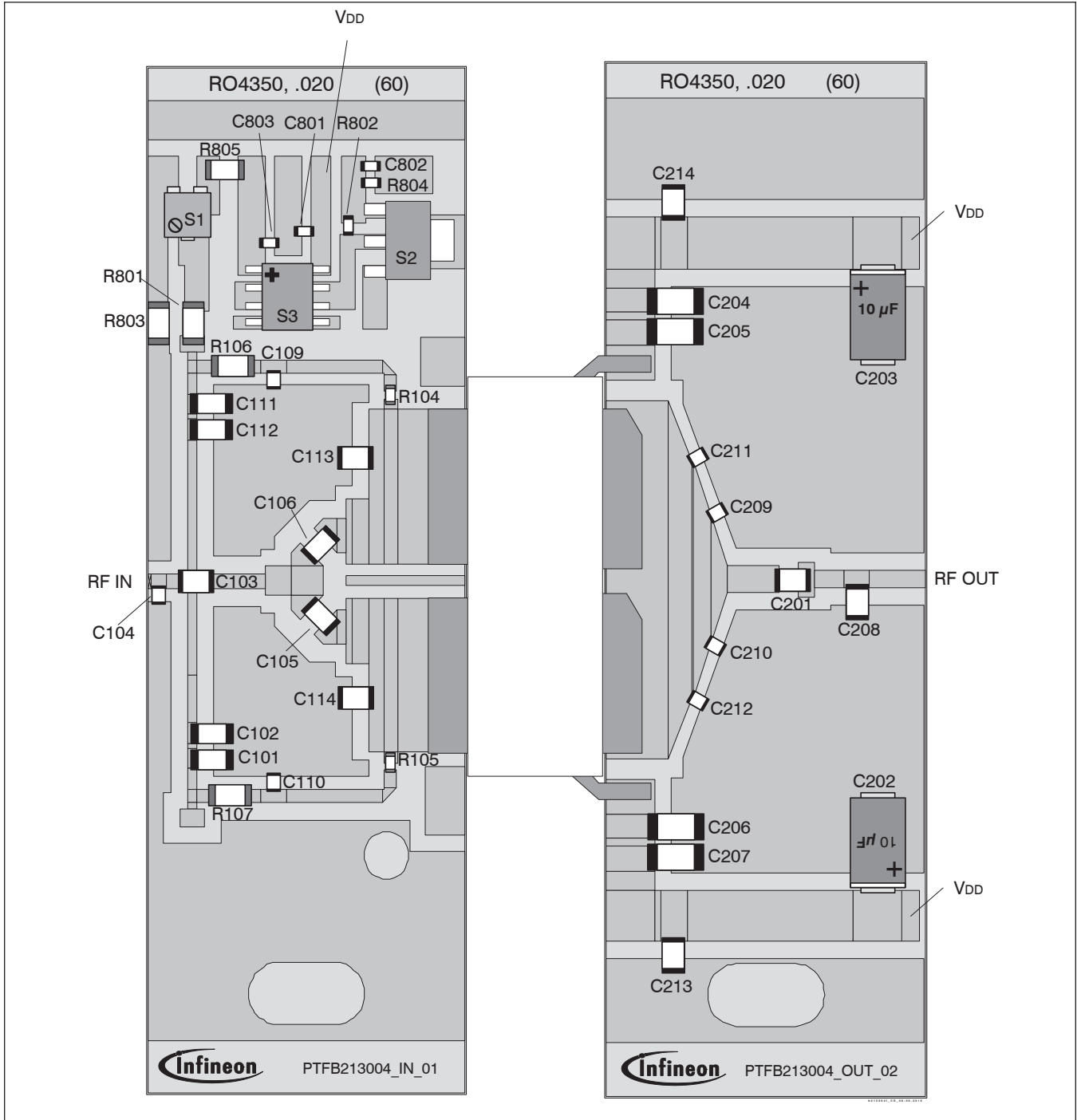

Reference circuit assembly diagram (not to scale)*

*Gerber Files for this circuit available on request

Reference Circuit (cont.)

Circuit Assembly Information

Component	Description	Suggested Manufacturer	P/N
Input			
C101, C108, C111	Chip capacitor, 0.1 μ F	Digi-Key	PCC104BTR-ND
C102, C112	Chip capacitor, 4.7 μ F	Digi-Key	493-2372-2-ND
C103	Chip capacitor, 8.2 pF	ATC	ATC100B8R2BW500XB
C104	Chip capacitor, 0.7 pF	ATC	ATC100A0R7BW150XB
C105, C106	Chip capacitor, 10 pF	ATC	ATC100B100FW500XB
C107	Capacitor, 10 μ F	Digi-Key	399-1655-2-ND
C109, C110	Chip capacitor, 10 pF	ATC	ATC100A100FW150XB
C113, C114	Chip capacitor, 0.6 pF	ATC	ATC100B0R6BW500XB
C801, C802, C803	Chip capacitor, 1000 pF	Digi-Key	PCC1772CT-ND
R101, R102	Resistor, 0 Ω	Digi-Key	P0.0ECT-ND
R103, R106, R107, R801, R803	Resistor, 10 Ω	Digi-Key	P10ECT-ND
R104, R105	Resistor, 0 Ω	Digi-Key	P0.0GCT-ND
R802	Resistor, 1200 Ω	Digi-Key	P1.2KECT-ND
R804	Resistor, 1300 Ω	Digi-Key	P1.3KGCT-ND
R805	Resistor, 100 Ω	Digi-Key	P100ECT-ND
S1	Potentiometer, 2k Ω	Digi-Key	3224W-202ECT-ND
S2	Transistor	Digi-Key	BCP56
S3	Voltage Regulator	Digi-Key	LM7805

Output

C201	Chip capacitor, 8.2 pF	ATC	ATC100B8R2BW500XB
C202, C203	Capacitor, 10 μ F	Digi-Key	399-1655-2-ND
C204, C207	Chip capacitor, 1 μ F	Digi-Key	445-1411-2-ND
C205, C206	Chip capacitor, 2.2 μ F	Digi-Key	445-1447-2-ND
C208	Chip capacitor, 0.4 pF	ATC	ATC100B0R4BW500XB
C209, C210, C211, C212	Chip capacitor, 1.2 pF	ATC	ATC100A1R2BW150XB
C213, C214	Capacitor, 10 μ F	Digi-Key	587-1818-2-ND

Pinout Diagram

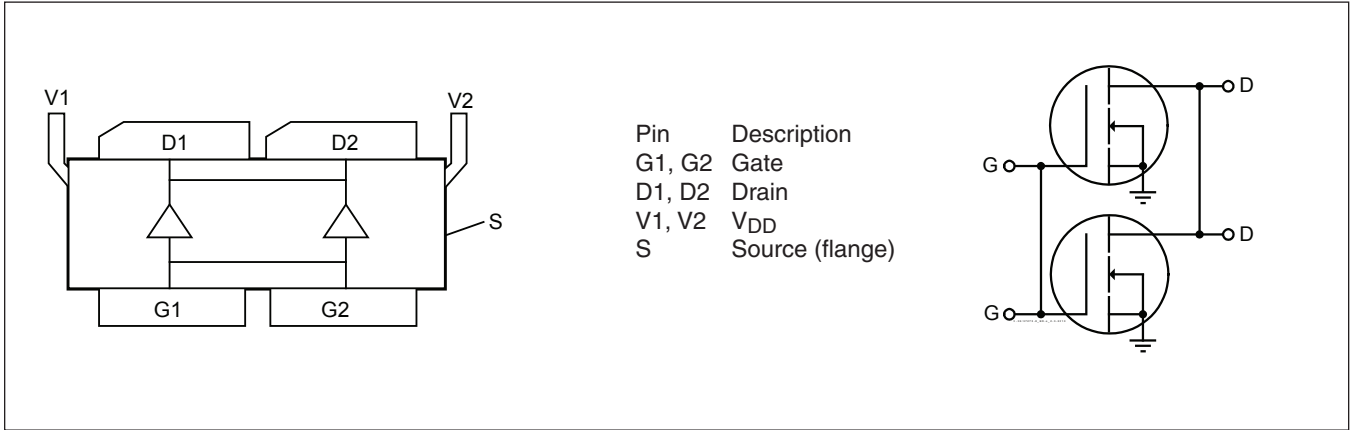

See next page for package outline specifications

Package Outline Specifications

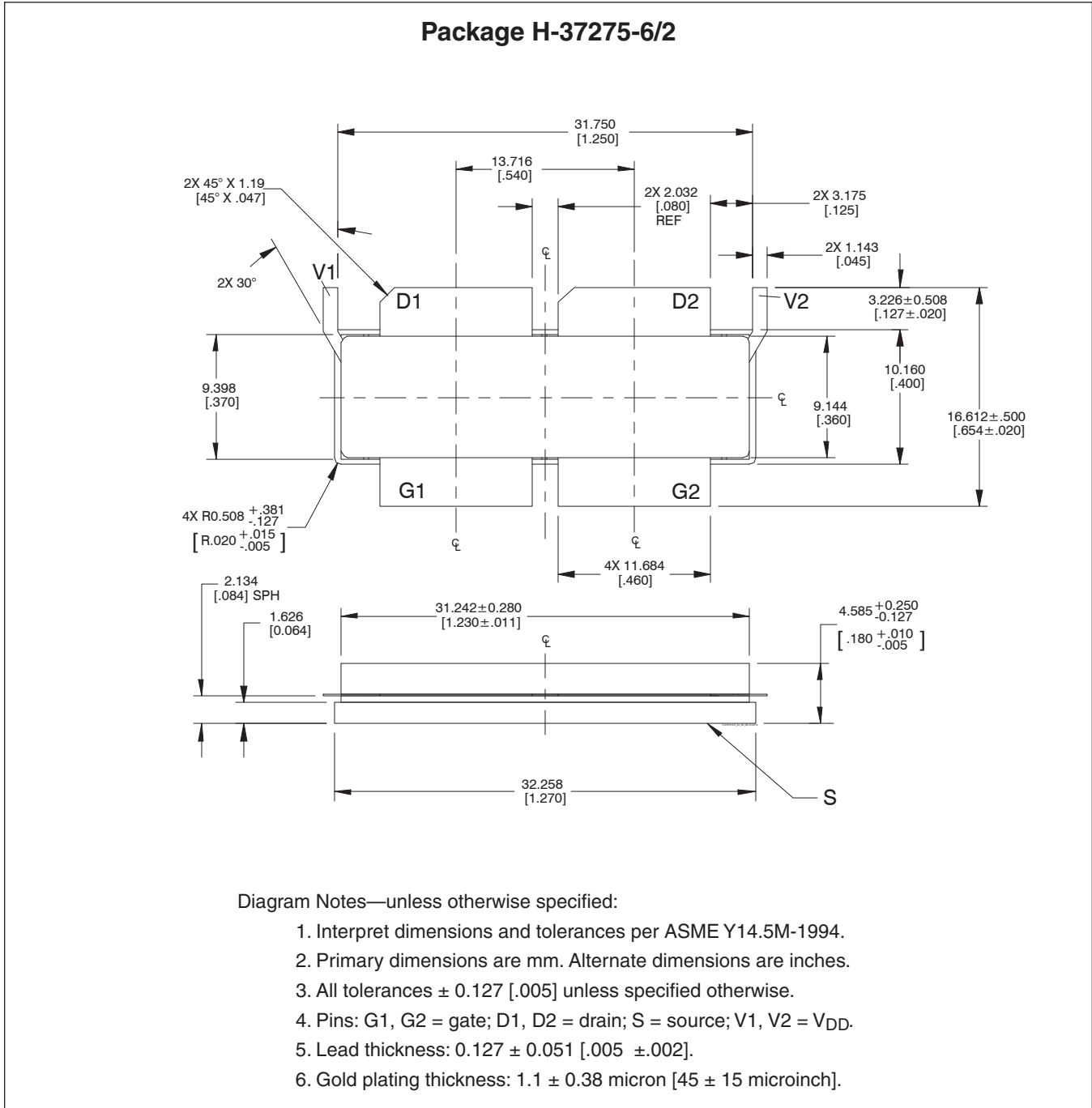

Find the latest and most complete information about products and packaging at the Infineon Internet page <http://www.infineon.com/rfpower>

Page	Subjects (major changes since last revision)
2	Updated ordering information

We Listen to Your Comments

Any information within this document that you feel is wrong, unclear or missing at all?

Your feedback will help us to continuously improve the quality of this document.

Please send your proposal (including a reference to this document) to:

highpowerRF@infineon.com

To request other information, contact us at:

+1 877 465 3667 (1-877-GO-LDMOS) USA

or +1 408 776 0600 International

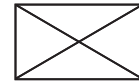

Edition 2016-06-15

Published by

Infineon Technologies AG

81726 Munich, Germany

© 2009 Infineon Technologies AG

All Rights Reserved.

Legal Disclaimer

The information given in this document shall in no event be regarded as a guarantee of conditions or characteristics.

With respect to any examples or hints given herein, any typical values stated herein and/or any information regarding the application of the device, Infineon Technologies hereby disclaims any and all warranties and liabilities of any kind, including without limitation, warranties of non-infringement of intellectual property rights of any third party.

Information

For further information on technology, delivery terms and conditions and prices, please contact the nearest Infineon Technologies Office (www.infineon.com/rfpower).

Warnings

Due to technical requirements, components may contain dangerous substances. For information on the types in question, please contact the nearest Infineon Technologies Office.

Infineon Technologies components may be used in life-support devices or systems only with the express written approval of Infineon Technologies, if a failure of such components can reasonably be expected to cause the failure of that life-support device or system or to affect the safety or effectiveness of that device or system. Life support devices or systems are intended to be implanted in the human body or to support and/or maintain and sustain and/or protect human life. If they fail, it is reasonable to assume that the health of the user or other persons may be endangered.