

Important notice

Dear Customer,

On 7 February 2017 the former NXP Standard Product business became a new company with the tradename **Nexperia**. Nexperia is an industry leading supplier of Discrete, Logic and PowerMOS semiconductors with its focus on the automotive, industrial, computing, consumer and wearable application markets

In data sheets and application notes which still contain NXP or Philips Semiconductors references, use the references to Nexperia, as shown below.

Instead of <http://www.nxp.com>, <http://www.philips.com/> or <http://www.semiconductors.philips.com/>, use <http://www.nexperia.com>

Instead of sales.addresses@www.nxp.com or sales.addresses@www.semiconductors.philips.com, use salesaddresses@nexperia.com (email)

Replace the copyright notice at the bottom of each page or elsewhere in the document, depending on the version, as shown below:

- © NXP N.V. (year). All rights reserved or © Koninklijke Philips Electronics N.V. (year). All rights reserved

Should be replaced with:

- © **Nexperia B.V. (year). All rights reserved.**

If you have any questions related to the data sheet, please contact our nearest sales office via e-mail or telephone (details via salesaddresses@nexperia.com). Thank you for your cooperation and understanding,

Kind regards,

Team Nexperia

PSMN009-100B

N-channel TrenchMOS SiliconMAX standard level FET

Rev. 02 — 6 July 2009

Product data sheet

1. Product profile

1.1 General description

SiliconMAX standard level N-channel enhancement mode Field-Effect Transistor (FET) in a plastic package using TrenchMOS technology. This product is designed and qualified for use in computing, communications, consumer and industrial applications only.

1.2 Features and benefits

- Low conduction losses due to low on-state resistance
- Suitable for high frequency applications due to fast switching characteristics

1.3 Applications

- High frequency computer motherboard DC-to-DC convertors
- OR-ing applications

1.4 Quick reference data

Table 1. Quick reference

| Symbol | Parameter | Conditions | Min | Typ | Max | Unit |
|--------------------------------|----------------------------------|---|-----|-----|-----|------------|
| V_{DS} | drain-source voltage | $T_j \geq 25\text{ °C}; T_j \leq 175\text{ °C}$ | - | - | 100 | V |
| I_D | drain current | $T_{mb} = 25\text{ °C}; V_{GS} = 10\text{ V};$ see Figure 1 ; see Figure 3 | - | - | 75 | A |
| P_{tot} | total power dissipation | $T_{mb} = 25\text{ °C};$ see Figure 2 | - | - | 230 | W |
| Dynamic characteristics | | | | | | |
| Q_{GD} | gate-drain charge | $V_{GS} = 10\text{ V}; I_D = 75\text{ A};$ $V_{DS} = 80\text{ V}; T_j = 25\text{ °C};$ see Figure 11 | - | 44 | - | nC |
| Static characteristics | | | | | | |
| $R_{DS(on)}$ | drain-source on-state resistance | $V_{GS} = 10\text{ V}; I_D = 25\text{ A};$ $T_j = 25\text{ °C};$ see Figure 9 ; see Figure 10 | - | 7.5 | 8.8 | m Ω |

2. Pinning information

Table 2. Pinning information

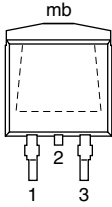
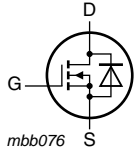
| Pin | Symbol | Description | Simplified outline | Graphic symbol |
|-----|--------|-----------------------------------|---|--|
| 1 | G | gate |  <p>SOT404 (D2PAK)</p> |  <p><i>mbb076</i></p> |
| 2 | D | drain [1] | | |
| 3 | S | source | | |
| mb | D | mounting base; connected to drain | | |

[1] It is not possible to make connection to pin 2.

3. Ordering information

Table 3. Ordering information

| Type number | Package | | Version |
|--------------|---------|--|---------|
| | Name | Description | |
| PSMN009-100B | D2PAK | plastic single-ended surface-mounted package (D2PAK); 3 leads (one lead cropped) | SOT404 |

4. Limiting values

Table 4. Limiting values

In accordance with the Absolute Maximum Rating System (IEC 60134).

| Symbol | Parameter | Conditions | Min | Max | Unit |
|------------------|--------------------------|--|-----|-----|------|
| V _{DS} | drain-source voltage | T _j ≥ 25 °C; T _j ≤ 175 °C | - | 100 | V |
| V _{DGR} | drain-gate voltage | T _j ≤ 175 °C; T _j ≥ 25 °C; R _{GS} = 20 kΩ | - | 100 | V |
| V _{GS} | gate-source voltage | | -20 | 20 | V |
| I _D | drain current | V _{GS} = 10 V; T _{mb} = 100 °C; see Figure 1 V _{GS} = 10 V; T _{mb} = 25 °C; see Figure 1 ; see Figure 3 | - | 65 | A |
| I _{DM} | peak drain current | t _p ≤ 10 μs; pulsed; T _{mb} = 25 °C; see Figure 3 | - | 400 | A |
| P _{tot} | total power dissipation | T _{mb} = 25 °C; see Figure 2 | - | 230 | W |
| T _{stg} | storage temperature | | -55 | 175 | °C |
| T _j | junction temperature | | -55 | 175 | °C |
| V _{GSM} | peak gate-source voltage | pulsed; t _p ≤ 50 μs; T _j ≤ 150 °C; δ = 25 % | -30 | 30 | V |

Source-drain diode

| | | | | | |
|-----------------|---------------------|---|---|-----|---|
| I _S | source current | T _{mb} = 25 °C | - | 75 | A |
| I _{SM} | peak source current | t _p ≤ 10 μs; pulsed; T _{mb} = 25 °C | - | 400 | A |

Avalanche ruggedness

| | | | | | |
|----------------------|---|--|---|-----|----|
| E _{DS(AL)S} | non-repetitive drain-source avalanche energy | V _{GS} = 10 V; T _{j(init)} = 25 °C; I _D = 35 A; V _{sup} = 15 V; unclamped; t _p = 0.1 ms; R _{GS} = 50 Ω | - | 120 | mJ |
| I _{DS(AL)S} | non-repetitive drain-source avalanche current | V _{GS} = 10 V; V _{sup} = 15 V; R _{GS} = 50 Ω; T _{j(init)} = 25 °C; unclamped | - | 75 | A |

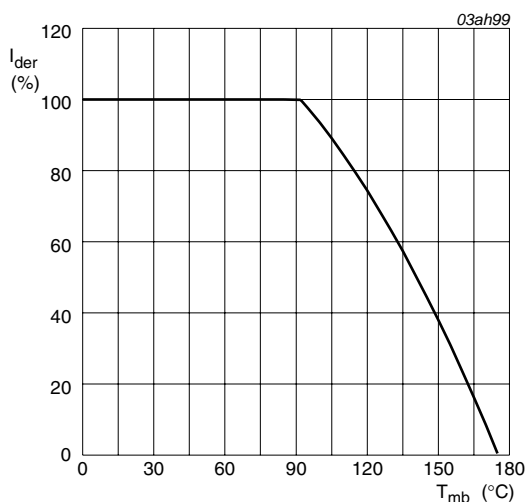

$$I_{der} = \frac{I_D}{I_{D(25^\circ\text{C})}} \times 100\%$$

Fig 1. Normalized continuous drain current as a function of mounting base temperature

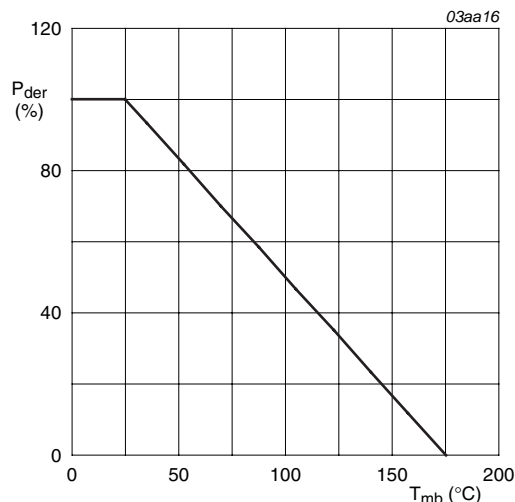

$$P_{der} = \frac{P_{tot}}{P_{tot(25^\circ\text{C})}} \times 100\%$$

Fig 2. Normalized total power dissipation as a function of mounting base temperature

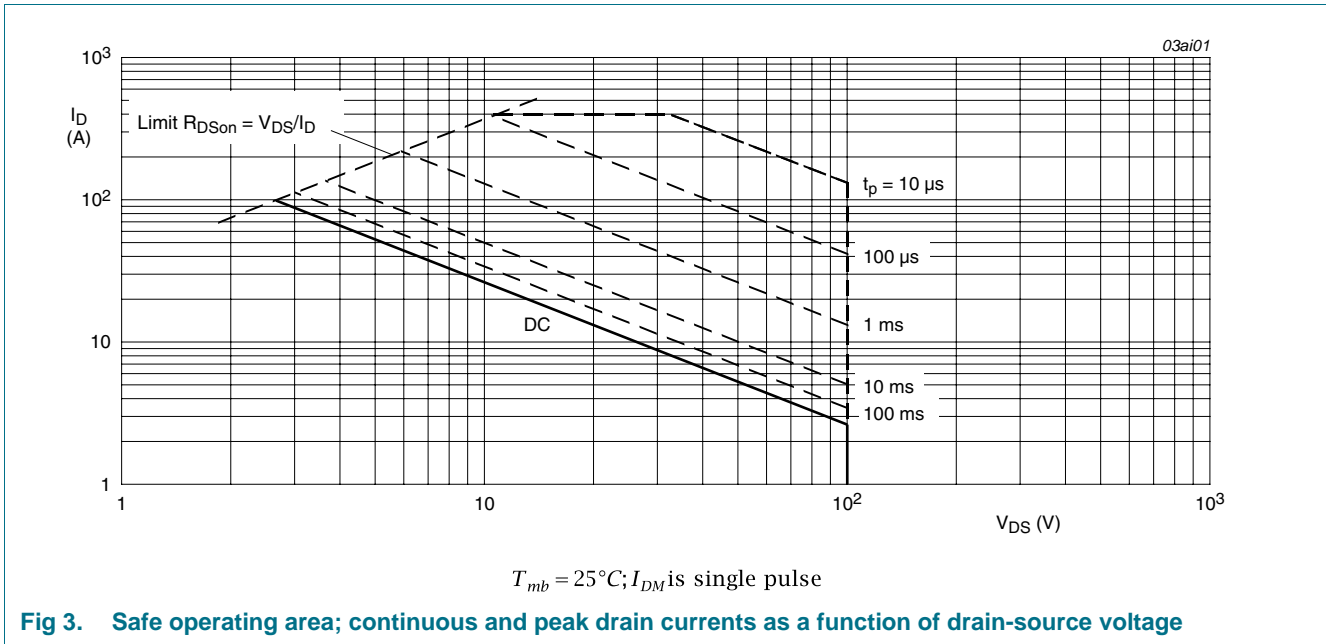

5. Thermal characteristics

Table 5. Thermal characteristics

| Symbol | Parameter | Conditions | Min | Typ | Max | Unit |
|----------------|---|---|-----|-----|------|------|
| $R_{th(j-mb)}$ | thermal resistance from junction to mounting base | see Figure 4 | - | - | 0.65 | K/W |
| $R_{th(j-a)}$ | thermal resistance from junction to ambient | minimum footprint; mounted on a printed-circuit board | - | 50 | - | K/W |

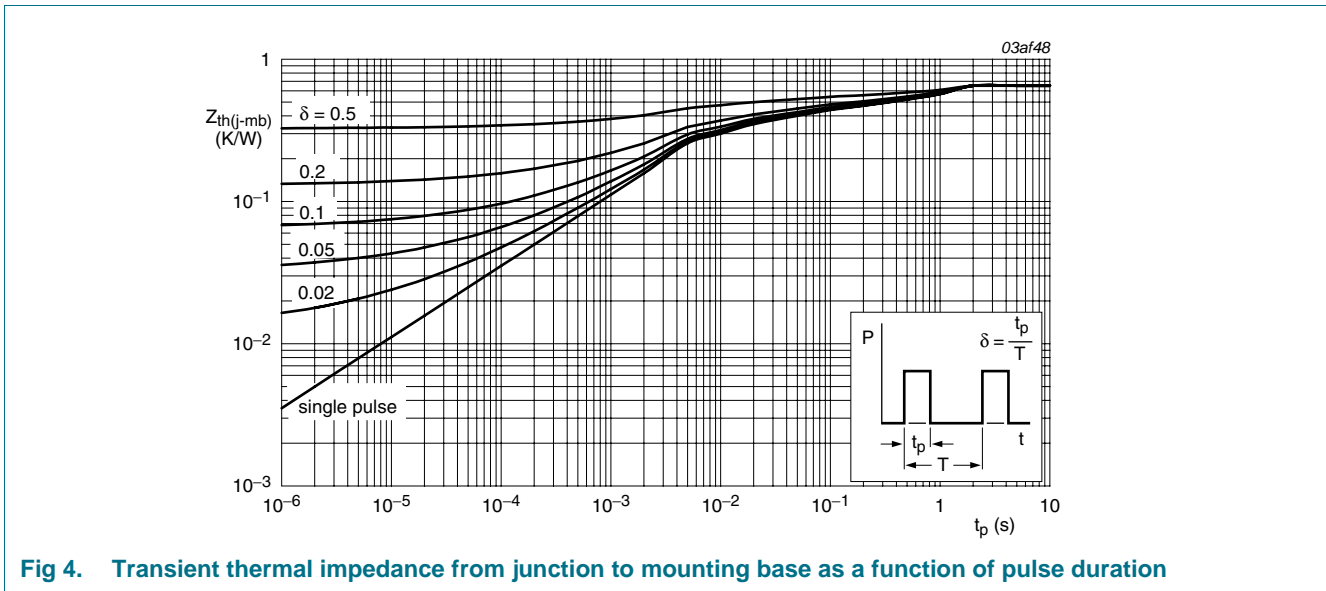
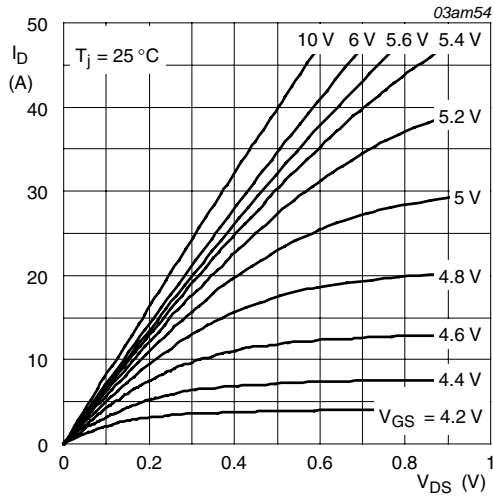

Fig 4. Transient thermal impedance from junction to mounting base as a function of pulse duration

6. Characteristics

Table 6. Characteristics

| Symbol | Parameter | Conditions | Min | Typ | Max | Unit |
|--------------------------------|----------------------------------|--|-----|-------|------|---------------|
| Static characteristics | | | | | | |
| $V_{(BR)DSS}$ | drain-source breakdown voltage | $I_D = 0.25 \text{ mA}; V_{GS} = 0 \text{ V}; T_j = -55 \text{ }^\circ\text{C}$ | 90 | - | - | V |
| | | $I_D = 0.25 \text{ mA}; V_{GS} = 0 \text{ V}; T_j = 25 \text{ }^\circ\text{C}$ | 100 | - | - | V |
| $V_{GS(th)}$ | gate-source threshold voltage | $I_D = 1 \text{ mA}; V_{DS} = V_{GS}; T_j = 175 \text{ }^\circ\text{C};$ see Figure 8 | 1 | - | - | V |
| | | $I_D = 1 \text{ mA}; V_{DS} = V_{GS}; T_j = 25 \text{ }^\circ\text{C};$ see Figure 8 | 2 | 3 | 4 | V |
| | | $I_D = 1 \text{ mA}; V_{DS} = V_{GS}; T_j = -55 \text{ }^\circ\text{C};$ see Figure 8 | - | - | 4.4 | V |
| I_{DSS} | drain leakage current | $V_{DS} = 30 \text{ V}; V_{GS} = 0 \text{ V}; T_j = 175 \text{ }^\circ\text{C}$ | - | - | 500 | μA |
| | | $V_{DS} = 30 \text{ V}; V_{GS} = 0 \text{ V}; T_j = 25 \text{ }^\circ\text{C}$ | - | 0.02 | 1 | μA |
| I_{GSS} | gate leakage current | $V_{GS} = 20 \text{ V}; V_{DS} = 0 \text{ V}; T_j = 25 \text{ }^\circ\text{C}$ | - | 10 | 100 | nA |
| | | $V_{GS} = -20 \text{ V}; V_{DS} = 0 \text{ V}; T_j = 25 \text{ }^\circ\text{C}$ | - | 10 | 100 | nA |
| $R_{DS(on)}$ | drain-source on-state resistance | $V_{GS} = 10 \text{ V}; I_D = 25 \text{ A}; T_j = 175 \text{ }^\circ\text{C};$ see Figure 9 ; see Figure 10 | - | 20.25 | 23.8 | m Ω |
| | | $V_{GS} = 10 \text{ V}; I_D = 25 \text{ A}; T_j = 25 \text{ }^\circ\text{C};$ see Figure 9 ; see Figure 10 | - | 7.5 | 8.8 | m Ω |
| Dynamic characteristics | | | | | | |
| $Q_{G(tot)}$ | total gate charge | $I_D = 75 \text{ A}; V_{DS} = 80 \text{ V}; V_{GS} = 10 \text{ V};$ $T_j = 25 \text{ }^\circ\text{C};$ see Figure 11 | - | 156 | - | nC |
| Q_{GS} | gate-source charge | | - | 31 | - | nC |
| Q_{GD} | gate-drain charge | | - | 44 | - | nC |
| C_{iss} | input capacitance | $V_{DS} = 25 \text{ V}; V_{GS} = 0 \text{ V}; f = 1 \text{ MHz};$ $T_j = 25 \text{ }^\circ\text{C};$ see Figure 12 | - | 8250 | - | pF |
| C_{oss} | output capacitance | | - | 620 | - | pF |
| C_{rss} | reverse transfer capacitance | | - | 300 | - | pF |
| $t_{d(on)}$ | turn-on delay time | $V_{DS} = 15 \text{ V}; R_L = 1.25 \text{ } \Omega; V_{GS} = 10 \text{ V};$ $R_{G(ext)} = 6 \text{ } \Omega; T_j = 25 \text{ }^\circ\text{C}; I_D = 12 \text{ A}$ | - | 38 | - | ns |
| t_r | rise time | | - | 59 | - | ns |
| $t_{d(off)}$ | turn-off delay time | | - | 120 | - | ns |
| t_f | fall time | | - | 43 | - | ns |
| Source-drain diode | | | | | | |
| V_{SD} | source-drain voltage | $I_S = 25 \text{ A}; V_{GS} = 0 \text{ V}; T_j = 25 \text{ }^\circ\text{C};$ see Figure 13 | - | 0.8 | 1.2 | V |



$T_j = 25^\circ\text{C}$

Fig 5. Output characteristics: drain current as a function of drain-source voltage; typical values

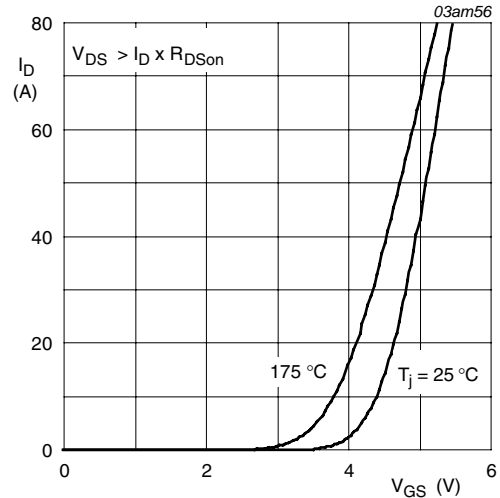

$T_j = 25^\circ\text{C}$ and $175^\circ\text{C}; V_{DS} > I_D \times R_{DSon}$

Fig 6. Transfer characteristics: drain current as a function of gate-source voltage; typical values

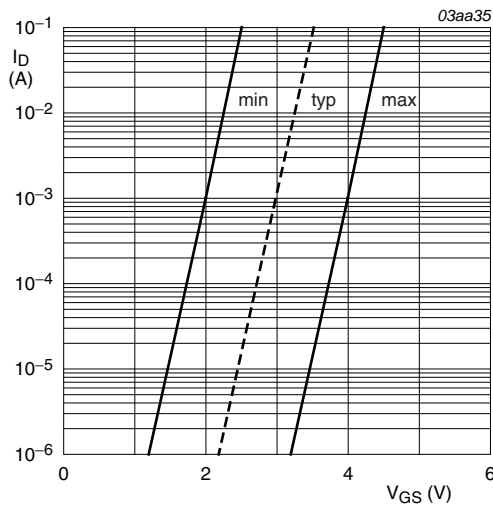

$T_j = 25^\circ\text{C}; V_{DS} = 5\text{V}$

Fig 7. Sub-threshold drain current as a function of gate-source voltage

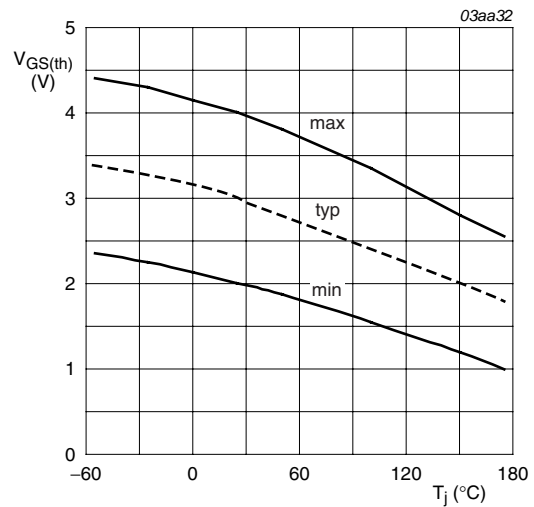

$I_D = 1\text{mA}; V_{DS} = V_{GS}$

Fig 8. Gate-source threshold voltage as a function of junction temperature

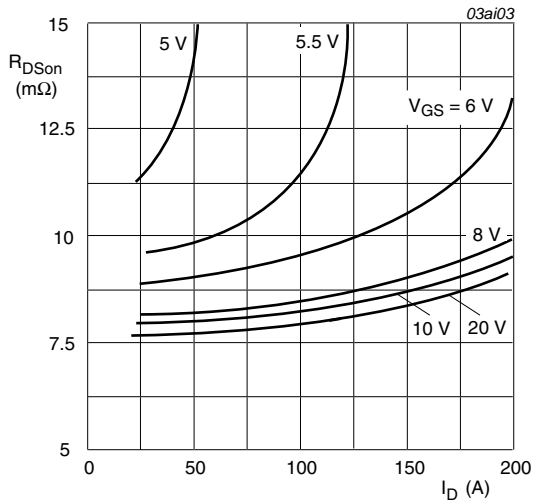

$T_j = 25^\circ C$

Fig 9. Drain-source on-state resistance as a function of drain current; typical values

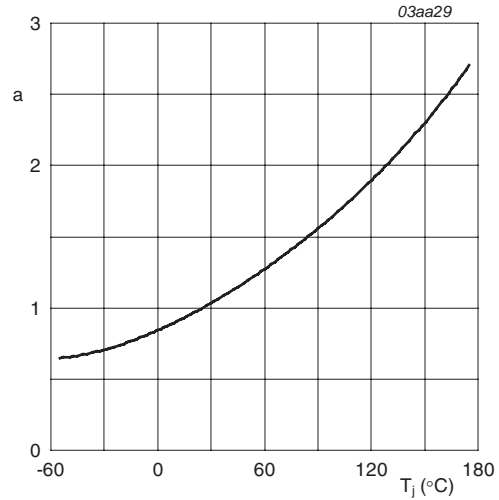

$$a = \frac{R_{DSon}}{R_{DSon(25^\circ C)}}$$

Fig 10. Normalized drain-source on-state resistance factor as a function of junction temperature

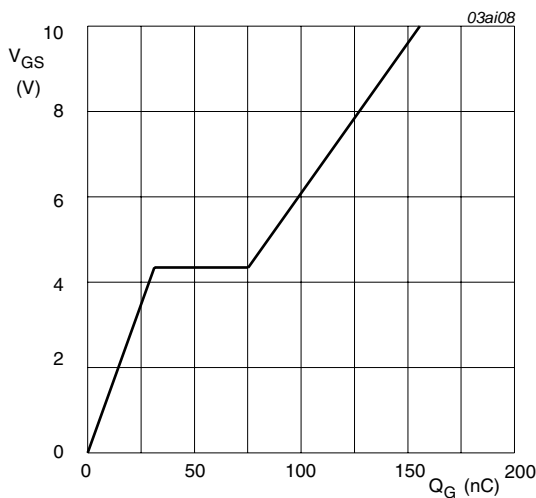

$I_D = 75A; V_{DS} = 80V$

Fig 11. Gate-source voltage as a function of gate charge; typical values

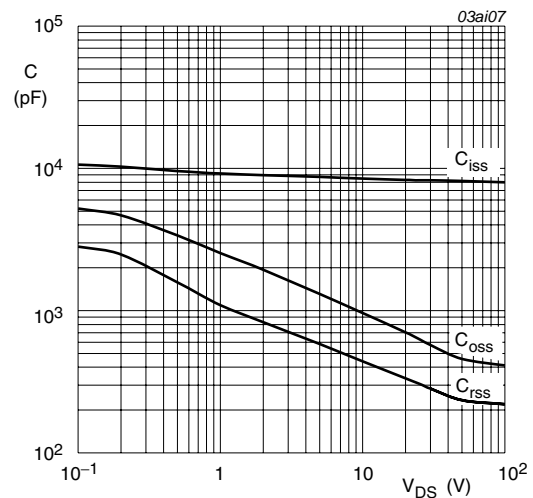

$V_{GS} = 0V; f = 1MHz$

Fig 12. Input, output and reverse transfer capacitances as a function of drain-source voltage; typical values

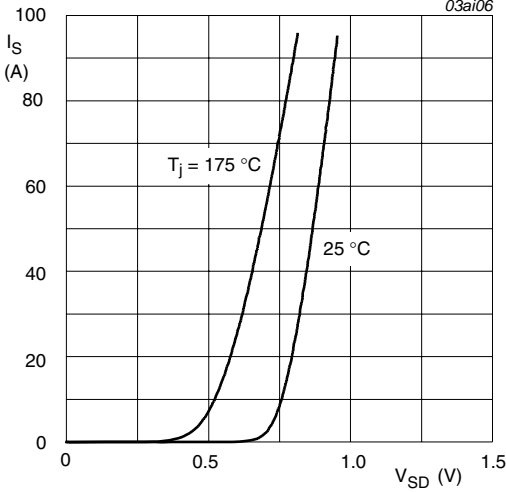

$T_j = 25^\circ\text{C}$ and $175^\circ\text{C}; V_{GS} = 0\text{V}$

Fig 13. Source current as a function of source-drain voltage; typical values

7. Package outline

Plastic single-ended surface-mounted package (D2PAK); 3 leads (one lead cropped)

SOT404

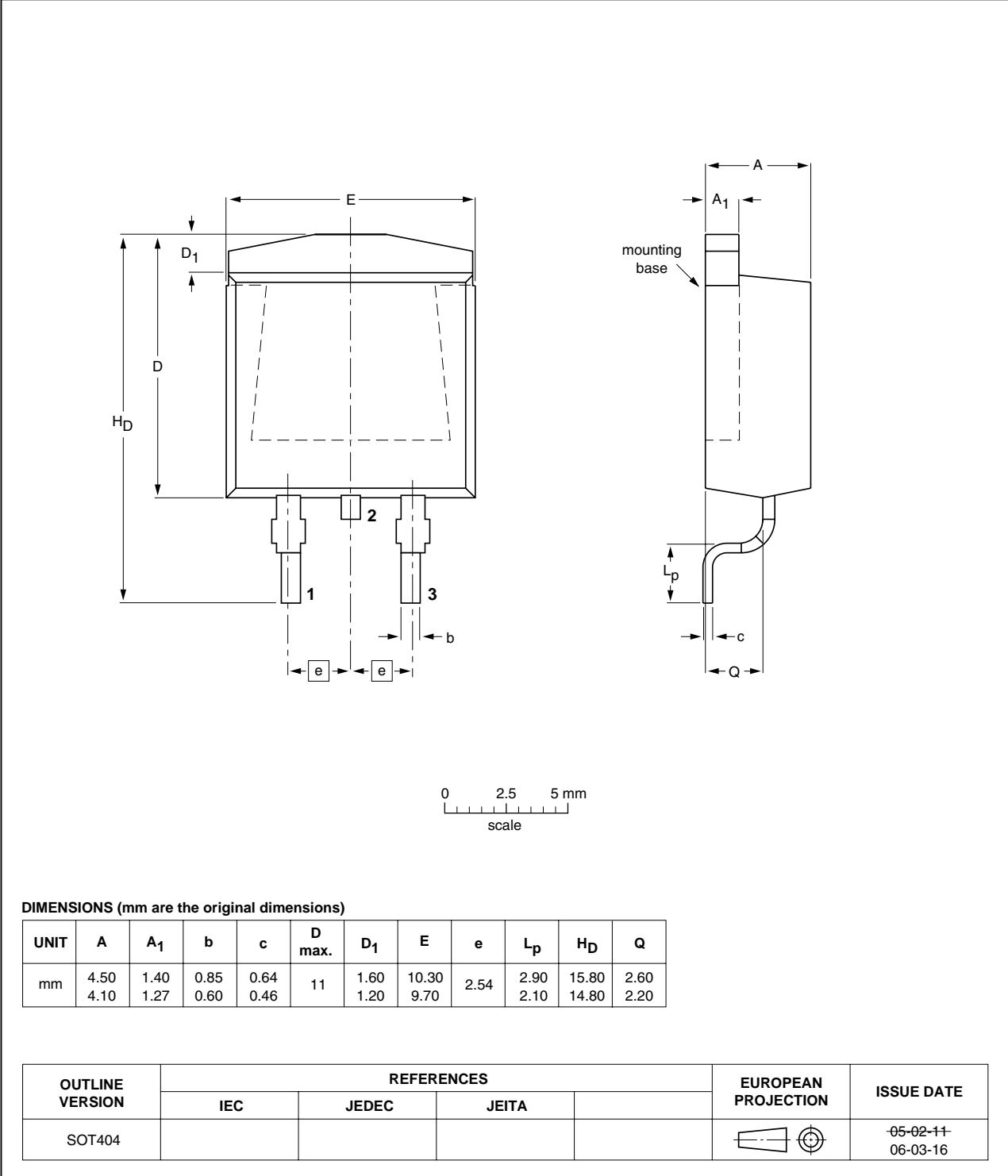

Fig 14. Package outline SOT404 (D2PAK)

8. Revision history

Table 7. Revision history

| Document ID | Release date | Data sheet status | Change notice | Supersedes |
|----------------------|--------------|--------------------|---------------|---|
| PSMN009-100B_2 | 20090706 | Product data sheet | - | PSMN009_100P_100B-01 |
| Modifications: | | | | |
| | | | | <ul style="list-style-type: none">• The format of this data sheet has been redesigned to comply with the new identity guidelines of NXP Semiconductors.• Legal texts have been adapted to the new company name where appropriate.• Type number PSMN009-100B separated from data sheet PSMN009_100P_100B-01. |
| PSMN009_100P_100B-01 | 20020429 | Product data | - | - |

9. Legal information

9.1 Data sheet status

| Document status ^{[1][2]} | Product status ^[3] | Definition |
|-----------------------------------|-------------------------------|---|
| Objective [short] data sheet | Development | This document contains data from the objective specification for product development. |
| Preliminary [short] data sheet | Qualification | This document contains data from the preliminary specification. |
| Product [short] data sheet | Production | This document contains the product specification. |

[1] Please consult the most recently issued document before initiating or completing a design.

[2] The term 'short data sheet' is explained in section "Definitions".

[3] The product status of device(s) described in this document may have changed since this document was published and may differ in case of multiple devices. The latest product status information is available on the Internet at <http://www.nxp.com>.

9.2 Definitions

Draft — The document is a draft version only. The content is still under internal review and subject to formal approval, which may result in modifications or additions. NXP Semiconductors does not give any representations or warranties as to the accuracy or completeness of information included herein and shall have no liability for the consequences of use of such information.

Short data sheet — A short data sheet is an extract from a full data sheet with the same product type number(s) and title. A short data sheet is intended for quick reference only and should not be relied upon to contain detailed and full information. For detailed and full information see the relevant full data sheet, which is available on request via the local NXP Semiconductors sales office. In case of any inconsistency or conflict with the short data sheet, the full data sheet shall prevail.

9.3 Disclaimers

General — Information in this document is believed to be accurate and reliable. However, NXP Semiconductors does not give any representations or warranties, expressed or implied, as to the accuracy or completeness of such information and shall have no liability for the consequences of use of such information.

Right to make changes — NXP Semiconductors reserves the right to make changes to information published in this document, including without limitation specifications and product descriptions, at any time and without notice. This document supersedes and replaces all information supplied prior to the publication hereof.

Suitability for use — NXP Semiconductors products are not designed, authorized or warranted to be suitable for use in medical, military, aircraft, space or life support equipment, nor in applications where failure or malfunction of an NXP Semiconductors product can reasonably be expected to result in personal injury, death or severe property or environmental damage. NXP Semiconductors accepts no liability for inclusion and/or use of NXP Semiconductors products in such equipment or applications and therefore such inclusion and/or use is at the customer's own risk.

Applications — Applications that are described herein for any of these products are for illustrative purposes only. NXP Semiconductors makes no representation or warranty that such applications will be suitable for the specified use without further testing or modification.

Quick reference data — The Quick reference data is an extract of the product data given in the Limiting values and Characteristics sections of this document, and as such is not complete, exhaustive or legally binding.

Limiting values — Stress above one or more limiting values (as defined in the Absolute Maximum Ratings System of IEC 60134) may cause permanent damage to the device. Limiting values are stress ratings only and operation of the device at these or any other conditions above those given in the Characteristics sections of this document is not implied. Exposure to limiting values for extended periods may affect device reliability.

Terms and conditions of sale — NXP Semiconductors products are sold subject to the general terms and conditions of commercial sale, as published at <http://www.nxp.com/profile/terms>, including those pertaining to warranty, intellectual property rights infringement and limitation of liability, unless explicitly otherwise agreed to in writing by NXP Semiconductors. In case of any inconsistency or conflict between information in this document and such terms and conditions, the latter will prevail.

No offer to sell or license — Nothing in this document may be interpreted or construed as an offer to sell products that is open for acceptance or the grant, conveyance or implication of any license under any copyrights, patents or other industrial or intellectual property rights.

Export control — This document as well as the item(s) described herein may be subject to export control regulations. Export might require a prior authorization from national authorities.

9.4 Trademarks

Notice: All referenced brands, product names, service names and trademarks are the property of their respective owners.

TrenchMOS — is a trademark of NXP B.V.

10. Contact information

For more information, please visit: <http://www.nxp.com>

For sales office addresses, please send an email to: salesaddresses@nxp.com

11. Contents

- 1 Product profile1**
- 1.1 General description1
- 1.2 Features and benefits1
- 1.3 Applications1
- 1.4 Quick reference data1
- 2 Pinning information2**
- 3 Ordering information2**
- 4 Limiting values3**
- 5 Thermal characteristics5**
- 6 Characteristics6**
- 7 Package outline10**
- 8 Revision history11**
- 9 Legal information12**
- 9.1 Data sheet status12
- 9.2 Definitions12
- 9.3 Disclaimers12
- 9.4 Trademarks12
- 10 Contact information12**

Please be aware that important notices concerning this document and the product(s) described herein, have been included in section 'Legal information'.



© NXP B.V. 2009.

All rights reserved.

For more information, please visit: <http://www.nxp.com>

For sales office addresses, please send an email to: salesaddresses@nxp.com

Date of release: 6 July 2009

Document identifier: PSMN009-100B_2