

PROTECTION PRODUCTS - RailClamp®
Description

RClamp® TVSdiodes are ultra low capacitance devices designed to protect sensitive electronics from damage or latch-up due to ESD, EFT, and EOS. They are designed for use on high speed ports in applications such as cell phones, notebook computers, and other portable electronics. These devices offer desirable characteristics for board level protection including fast response time, low operating and clamping voltage, and no device degradation.

RClamp5011T feature extremely good ESD protection characteristics highlighted by low typical dynamic resistance of 0.33 Ohms, low peak ESD clamping voltage, and high ESD withstand voltage (+/-12kV contact per IEC 61000-4-2). Low maximum capacitance (0.45pF at VR=0V) minimizes loading on sensitive circuits. Each device will protect one high-speed data line operating at 5 Volts.

RClamp5011T is in a 2-pin SLP0806P2T package measuring 0.8 x 0.6 x 0.4mm. Leads are finished with lead-free NiPdAu. The combination of working voltage, low dynamic resistance, and low capacitance makes these devices ideal for use in applications such as HDMI, MHL, and USB 3.0.

Features

- ◆ Transient protection to
IEC 61000-4-2 (ESD) 15kV (air), 12kV (contact)
IEC 61000-4-4 (EFT) 40A (5/50ns)
IEC 61000-4-5 (Lightning) 4A (8/20µs)
- ◆ Protects one high-speed data line
- ◆ Low capacitance: 0.45pF maximum
- ◆ Operating Voltage: 5V
- ◆ Low dynamic resistance: 0.33 Ohms (Typ)
- ◆ Low ESD clamping voltage
- ◆ Low leakage current
- ◆ Solid-state silicon-avalanche technology

Mechanical Characteristics

- ◆ SLP0806P2T package
- ◆ Pb-Free, Halogen Free, RoHS/WEEE Compliant
- ◆ Lead Finish: NiPdAu
- ◆ Molding compound flammability rating: UL 94V-0
- ◆ Marking : Marking code
- ◆ Packaging : Tape and Reel

Applications

- ◆ HDMI 1.4
- ◆ MHL
- ◆ USB 3.0
- ◆ MiPi / MDDI
- ◆ FM Antenna

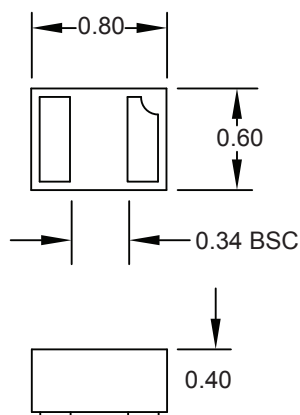
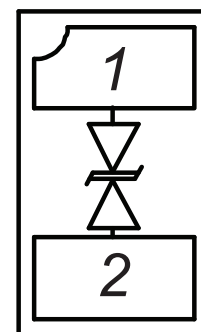
Nominal Dimensions

Functional Schematic

PROTECTION PRODUCTS

Absolute Maximum Ratings

Rating	Symbol	Value	Units
Peak Pulse Current ($t_p = 8/20\mu s$)	I_{PP}	4	A
ESD per IEC 61000-4-2 (Air) ¹	V_{ESD}	15	kV
ESD per IEC 61000-4-2 (Contact) ¹		12	
Operating Temperature	T_J	-40 to +85	°C
Storage Temperature	T_{STG}	-55 to +150	°C

Electrical Characteristics (T=25°C unless otherwise specified)

Parameter	Symbol	Conditions	Min.	Typ.	Max.	Units
Reverse Stand-Off Voltage	V_{RWM}	T = -40 to +85°C			5	V
Punch-Through Voltage	V_{BR}	$I_{PT} = 1mA$	6.5	7	10.5	V
Reverse Leakage Current	I_R	$V_{RWM} = 5V$		<5	100	nA
Clamping Voltage	V_C	$I_{PP} = 2A, t_p = 8/20\mu s$			11.5	V
		$I_{PP} = 4A, t_p = 8/20\mu s$			14	V
ESD Clamping Voltage ²	V_C	$I_{PP} = 4A$ $t_p = 0.2/100ns$		9		V
ESD Clamping Voltage ²	V_C	$I_{PP} = 16A$ $t_p = 0.2/100ns$		13		V
Dynamic Resistance ^{2,3}	R_{DYN}	$t_p = 0.2/100ns$		0.33		Ohms
Junction Capacitance	C_J	VR = 0V; f = 1MHz		0.40	0.45	pF

Notes

- 1) Measured with a 40dB attenuator, 50 Ohm scope input impedance, 2GHz bandwidth. ESD gun return path connected to ESD ground plane.
- 2) Transmission Line Pulse Test (TLP) Settings: $t_p = 100ns$, $t_r = 0.2ns$, I_{TLP} and V_{TLP} averaging window: $t_1 = 70ns$ to $t_2 = 90ns$.
- 3) Dynamic resistance calculated from $I_{TLP} = 4A$ to $I_{TLP} = 16A$

Typical Characteristics

ESD Clamping (+8kV Contact per IEC 61000-4-2)

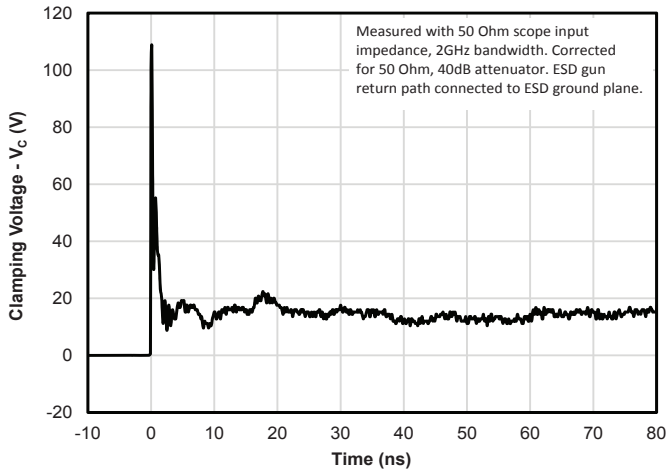

ESD Clamping (-8kV Contact per IEC 61000-4-2)

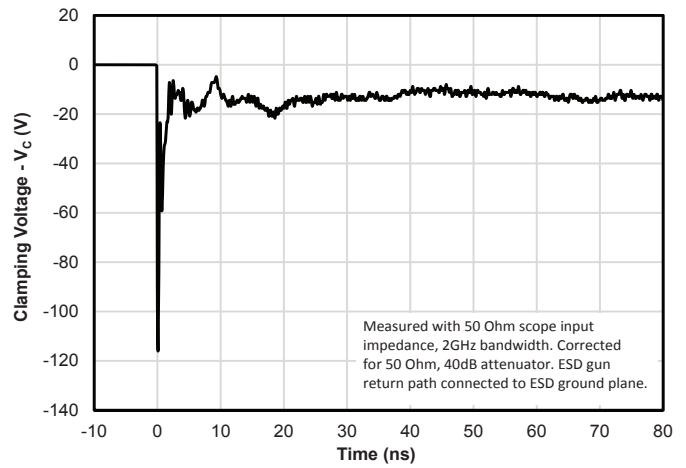

TLP Characteristic

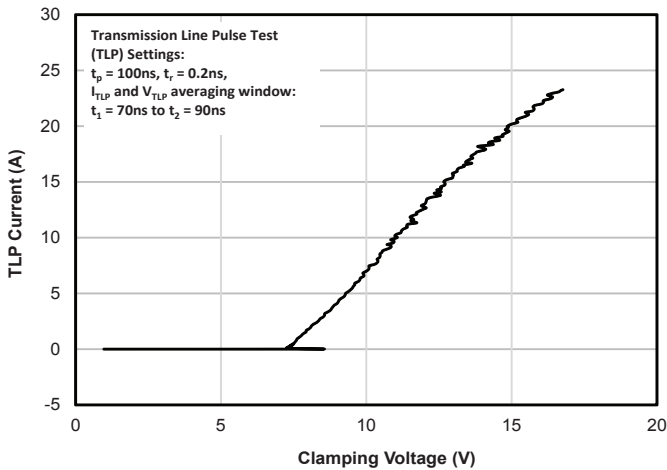

Clamping Voltage vs. Peak Pulse Current (8/20us Pulse)

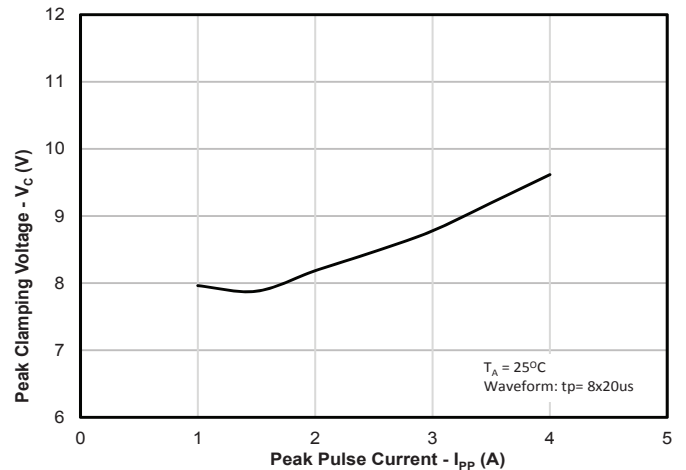

Capacitance vs. Reverse Voltage

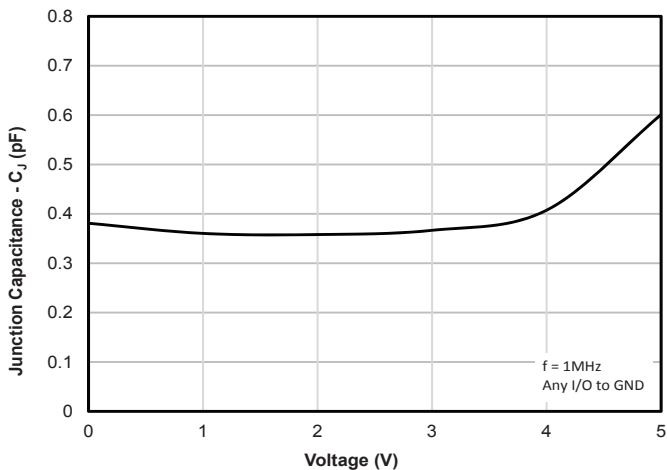

Insertion Loss - S21

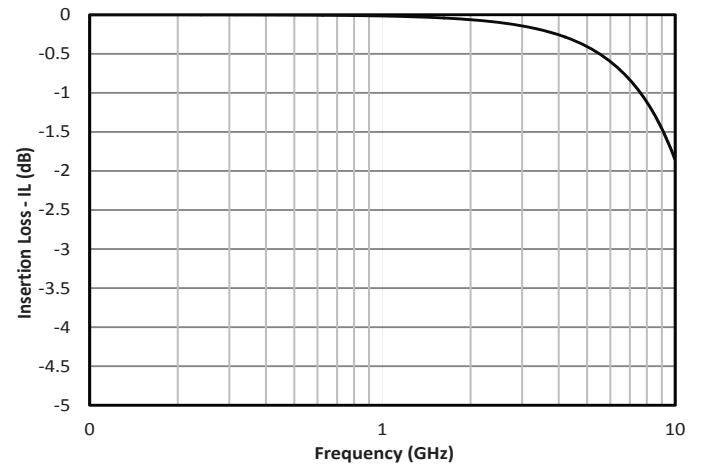

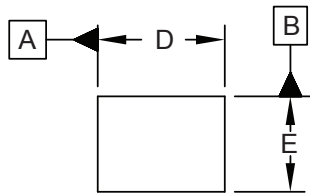

TOP VIEW

DIMENSIONS			
DIM	MILLIMETERS		
	MIN	NOM	MAX
A	0.37	0.40	0.43
A1	0.00	0.03	0.05
b	0.45	0.50	0.55
D	0.75	0.80	0.875
E	0.55	0.60	0.675
e	0.34 BSC		
L	0.13	0.18	0.23
R	0.05	0.10	0.15
N	2		
aaa	0.08		
bbb	0.10		

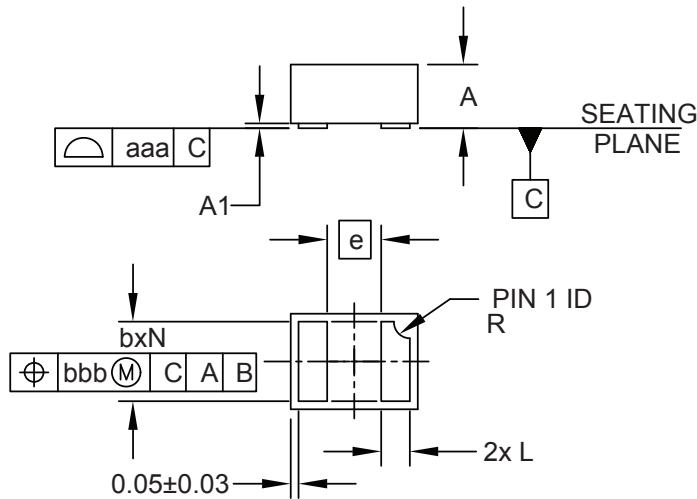

BOTTOM VIEW

NOTES:

1. CONTROLLING DIMENSIONS ARE IN MILLIMETERS (ANGLES IN DEGREES).

Land Pattern - SLP0806P2T

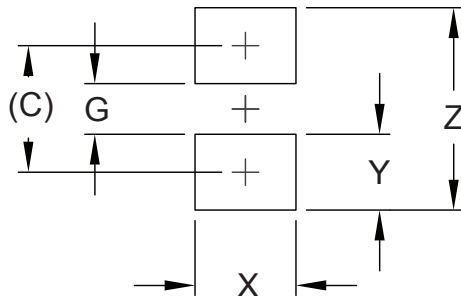

DIMENSIONS	
DIM	MILLIMETERS
(C)	0.75
G	0.30
X	0.60
Y	0.45
Z	1.20

NOTES:

1. CONTROLLING DIMENSIONS ARE IN MILLIMETERS (ANGLES IN DEGREES).
2. THIS LAND PATTERN IS FOR REFERENCE PURPOSES ONLY.
CONSULT YOUR MANUFACTURING GROUP TO ENSURE YOUR COMPANY'S MANUFACTURING GUIDELINES ARE MET.

PROTECTION PRODUCTS

Marking

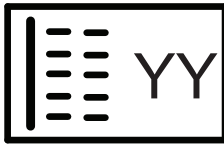

Notes: Marking will also include line matrix date code

Ordering Information

Part Number	Qty per Reel	Pocket Pitch	Reel Size
RClamp5011T.TNT	10000	2mm	7"

RailClamp and RClamp are registered trademarks of Semtech Corporation.

Tape and Reel Specification

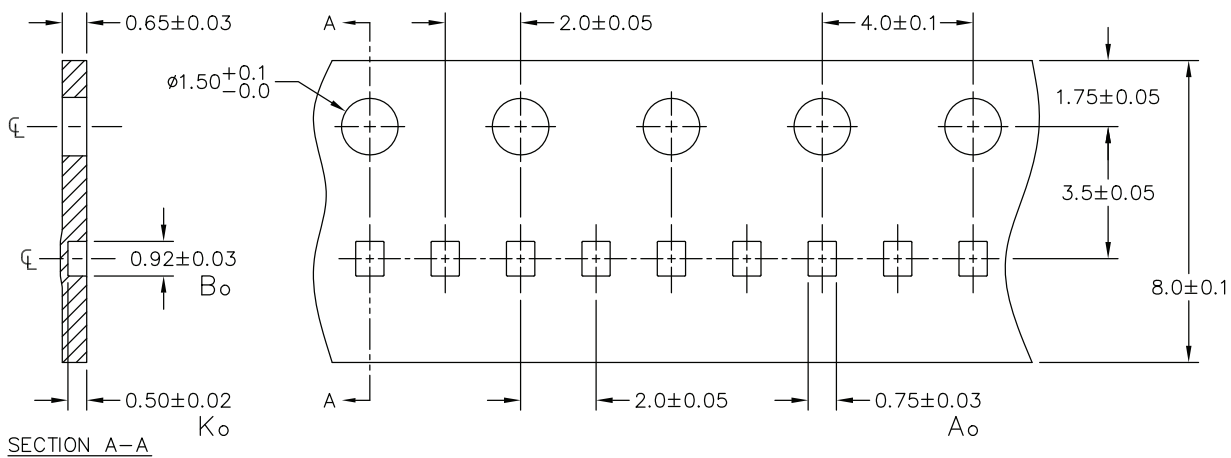

NOTES: ALL DIMENSIONS IN MILLIMETERS UNLESS OTHERWISE SPECIFIED.

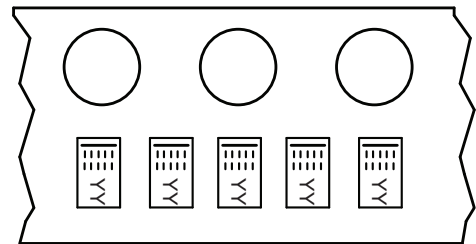

Contact Information for Semtech International AG

Taiwan Branch	Tel: 886-2-2748-3380 Fax: 886-2-2748-3390	Japan (Tokyo) Office	Tel: 81-3-5719-7560 Fax: 81-3-5719-7561
Korea Branch	Tel: 82-2-527-4377 Fax: 82-2-527-4376	Semtech Limited (U.K.)	Tel: 44-1794-527-600 Fax: 44-1794-527-601
Shanghai Office	Tel: 86-21-6391-0830 Fax: 86-21-6391-0831	Semtech France SARL	Tel: 33-(0)169-28-22-00 Fax: 33-(0)169-28-12-98
Japan (Osaka) Office	Tel: 81-6-6347-6570 Fax: 81-6-6347-6571	Semtech Germany GmbH	Tel: 49-(0)8161-140-123 Fax: 49-(0)8161-140-124

Semtech International AG is a wholly-owned subsidiary of Semtech Corporation, which has its headquarters in the U.S.A.